

South Australia

## **Road Traffic (Vehicle Standards) Rules 1999**

under the *Road Traffic Act 1961*

---

### **Contents**

#### **Part 1—Preliminary**

- 1 Citation etc
- 3 Definitions—the dictionary etc
- 4 Diagrams
- 5 Notes
- 6 Examples

#### **Part 2—Application of the vehicle standards**

- 7 Application to vehicles and combinations on roads and road-related areas
- 8 Meaning of road
- 9 Meaning of road-related area
- 10 Vehicles to which the Vehicle Standards do not apply
- 11 Non-application of Vehicle Standards—exemption under other laws
- 12 Non-application of Vehicle Standards—inconsistent ADR requirements
- 13 Non-application of Vehicle Standards—Motor Vehicle Standards Act approvals

#### **Part 3—Australian Design Rules**

##### **Division 1—Interpretation**

- 14 ADRs
- 15 National standards
- 16 References to national standards
- 17 Second edition ADRs
- 18 Third edition ADRs

##### **Division 2—Compliance with ADRs**

- 19 Compliance with second edition ADRs
- 20 Compliance with third edition ADRs
- 21 Exception to compliance with ADRs—vehicles that are not road vehicles
- 22 Exception to compliance with ADRs—Motor Vehicle Standards Act
- 23 Partial exception to compliance with ADRs—personally imported vehicles

#### **Part 4—Adopted standards**

- 24 Adopted standards
- 25 Reference to adopted standards
- 26 Exception to compliance with adopted standards

## Part 5—General safety requirements

### Division 1—All vehicles

- 27 Steering
- 28 Turning ability
- 29 Ability to travel backwards and forwards
- 30 Protrusions
- 31 Driver's view and vehicle controls
- 32 Seating
- 33 Mudguards and spray suppression
- 34 Horns, alarms etc
- 35 Rear vision mirrors
- 36 Rear vision mirrors—surfaces
- 37 Additional rear vision mirrors
- 38 Automatic transmission
- 39 Diesel engines
- 40 Bonnet securing devices
- 41 Electrical wiring, connections and installations
- 42 Television receivers and visual display units
- 43 Windscreens and windows
- 44 Window tinting
- 45 Windscreen wipers and washers
- 46 Wheels and tyres—size and capacity
- 47 Pneumatic tyres generally
- 48 Pneumatic tyres—carcass construction
- 49 Pneumatic tyres—size and capacity
- 50 Tyres—defects
- 51 Tyres for use on vehicles with GVM over 4.5 tonnes
- 52 Tyres—manufacturer's rating
- 53 Retreads
- 54 Tyre tread

### Division 2—Additional requirements for motor bikes

- 55 Steering gear and handlebars
- 56 Foot rests
- 57 Chain guards
- 57A Sidecars

## Part 6—Vehicle marking

- 58 Vehicle and engine identification numbers
- 59 White or silver band on certain vehicles
- 60 Warning signs for combinations over 22 metres long
- 61 Warning signs not to be displayed on other vehicles
- 62 Specifications for warning signs
- 63 Left-hand drive signs

## Part 7—Vehicle configuration and dimensions

### Division 1—Axles

- 64 Axle configuration
- 65 Relation between axles in axle group

## Division 2—Dimensions

- 66 Width
- 67 Length of single motor vehicles
- 68 Length of single trailers
- 69 Length of combinations
- 70 Rear overhang
- 71 Trailer drawbar length
- 72 Height
- 73 Ground clearance

## Part 8—Lights and reflectors

### Division 1—General requirements for lights

- 74 Certain requirements apply only at night
- 75 Prevention of glare
- 76 Pairs of lights

### Division 2—Headlights

- 77 Headlights to be fitted to vehicles
- 78 How headlights are to be fitted
- 79 How single headlights are to be fitted
- 80 How additional headlights are to be fitted
- 81 Performance of headlights
- 82 Effective range of headlights
- 83 Changing headlights from high-beam to low-beam position

### Division 3—Parking lights

- 84 Parking lights

### Division 4—Daytime running lights

- 85 Daytime running lights

### Division 5—Tail lights

- 86 Tail lights generally
- 87 Pattern of fitting tail lights
- 88 Performance of tail lights
- 89 Wiring of tail lights

### Division 6—Number plate lights

- 90 Number plate lights

### Division 7—Clearance lights

- 91 Front clearance lights
- 92 External cabin lights
- 93 Rear clearance lights

### Division 8—Side marker lights

- 94 Vehicles needing side marker lights
- 95 Location of side marker lights
- 96 Performance of side marker lights
- 97 Side marker lights and rear clearance lights

Division 9—Brake lights

- 98 Fitting brake lights
- 99 Performance and operation of brake lights

Division 10—Reversing lights

- 100 Reversing lights

Division 11—Direction indicator lights

- 101 Direction indicator lights on motor vehicles
- 102 Direction indicator lights on trailers
- 103 Location of direction indicator lights
- 104 Operation and visibility of direction indicator lights

Division 12—Fog lights

- 105 Front fog lights
- 106 Rear fog lights

Division 13—Interior lights

- 107 Interior lights

Division 14—Reflectors generally

- 108 General requirements for reflectors

Division 15—Rear reflectors

- 109 Rear reflectors

Division 16—Side reflectors

- 110 Compulsory side reflectors on pole-type trailers
- 111 Optional side reflectors

Division 17—Front reflectors

- 112 Compulsory front reflectors on trailers
- 113 Optional front reflectors

Division 18—Warning lights and signs on buses carrying children

- 114 Application of division
- 115 Fitting of warning lights and signs
- 116 Operation and performance of warning lights
- 117 Specifications for warning signs

Division 19—Other lights, reflectors, rear marking plates or signals

- 118 Other lights and reflectors
- 119 Rear marking plates
- 119A Fitting of rear marking plates
- 120 Signalling devices
- 121 Mechanical signalling devices
- 122 Turn signals

Division 20—Vehicles not required to have lights or reflectors

- 123 Certain vehicles used in daylight
- 124 Certain vehicles used for exhibition purposes

---

## Part 9—Braking systems

### Division 1—Brake requirements for all vehicles

- 125 Parts of a braking system
- 126 Provision for wear
- 127 Supply of air or vacuum to brakes
- 128 Performance of braking systems

### Division 2—Motor vehicle braking systems

- 129 Motor vehicle braking system requirements
- 130 Operation of brakes on motor vehicles
- 131 Air or vacuum brakes on motor vehicles

### Division 3—Trailer braking systems

- 132 Trailer braking requirements
- 133 Operation of brakes on trailers
- 134 Air or vacuum brakes on trailers

### Division 4—Additional brake requirements for B-double and long road trains

- 135 Application of Division to certain road trains
- 136 Braking system design for a prime mover in a B-double
- 137 Braking system design for motor vehicles in road trains
- 138 Braking system design for trailers in B-doubles or road trains
- 139 Air brakes of motor vehicles in B-doubles or road trains
- 140 Air brakes in a B-double or road train: least favoured chamber
- 141 Recovery of air pressure for brakes in B-doubles and road trains
- 142 Air supply for brakes in B-doubles and road trains
- 143 Brake line couplings
- 144 Simultaneous parking brake application
- 145 Capacity of air reservoirs

## Part 10—Control of emissions

### Division 1—Crank case gases and visible emissions

- 146 Crank case gases
- 147 Visible emissions

### Division 2—Exhaust systems

- 148 Exhaust systems

### Division 3—Noise emissions

- 149 Silencing device for exhaust systems
- 150 Stationary noise levels—car-type vehicles and motor bikes and motor trikes
- 151 Stationary noise levels—other vehicles with spark ignition engines
- 152 Stationary noise levels—other vehicles with diesel engines
- 153 Measurement of stationary noise levels

## Part 11—Alternative fuel systems for vehicle engines

- 154 Gaseous fuel powered vehicles

## Part 12—Maximum road speed limiting

- 155 Speed limiting
- 156 Exemptions from speed limiting

## Part 13—Mechanical connections between vehicles

### Division 1—Couplings on all types of vehicles

- 157 General coupling requirements
- 158 Drawbar couplings

### Division 2—Additional coupling requirements for B-doubles and long road trains

- 159 Application of Division to road trains
- 160 Couplings for B-doubles and road trains
- 161 Selection of fifth wheel couplings for B-doubles and road trains
- 162 D-value of a fifth wheel coupling
- 163 Mounting of fifth wheel couplings on B-doubles and road trains
- 164 Branding of fifth wheel couplings and turntables on B-doubles and road trains
- 165 Selection of kingpins for B-doubles and road trains
- 166 Attachment of kingpins on B-doubles and road trains
- 167 Branding of kingpins on B-doubles and road trains
- 168 Selection of couplings and drawbar eyes for roadtrains
- 169 Attachment of couplings and drawbar eyes on roadtrains
- 170 Branding of couplings and drawbar eyes on roadtrains
- 171 Tow coupling overhang on road trains

## Part 14—Other matters

- 172 Vehicle equipment
- 173 Restored vehicles
- 174 Retractable axles
- 175 Measurement of distance between parallel lines
- 176 Interpretation of certain second edition ADRs

## Dictionary

## Legislative history

---

# Part 1—Preliminary

## 1—Citation etc

- (1) These rules may be cited as the *Road Traffic (Vehicle Standards) Rules 1999*.
- (2) These rules are made pursuant to section 111 of the *Road Traffic Act 1961*.
- (3) In these rules, these rules are referred to as the *Vehicle Standards*.

### Notes—

- 1 Under section 112 of the *Road Traffic Act 1961* the driver and the owner and the operator of a vehicle driven or towed on a road are each guilty of an offence if the vehicle does not comply with the vehicle standards. For that purpose, *vehicle* includes a combination.

- 
- 2 Under section 161A of the *Road Traffic Act 1961*, certain vehicles can only be driven on roads with the approval of the Minister.

### **3—Definitions—the dictionary etc**

- (1) The dictionary at the end of the Vehicle Standards defines certain words and expressions, and includes signpost definitions to words and expressions defined elsewhere in the Vehicle Standards.

**Note—**

A signpost definition (eg road-related area see rule 9) is included in the dictionary if the definition applies outside the rule defining the word or expression.

- (2) The dictionary is part of the Vehicle Standards.
- (3) A definition in the Vehicle Standards applies to each use of the word or expression in the Vehicle Standards, unless the contrary intention appears.

### **4—Diagrams**

- (1) A diagram in the Vehicle Standards is part of the Vehicle Standards.
- (2) A diagram of something (except the essential diagram in rule 165) is an illustrative example of the thing in black and white, but does not represent its dimensions or the dimensions of any part of it.

**Note—**

The essential diagram in rule 165 provides the dimensions required for a 75 millimetre kingpin used in a B-double or road train.

### **5—Notes**

A note in the Vehicle Standards is explanatory and is not part of the Vehicle Standards.

### **6—Examples**

- (1) An example (whether or not in the form of a diagram) in the Vehicle Standards is part of the Vehicle Standards.
- (2) If the Vehicle Standards include an example of the operation of a provision of the Vehicle Standards:
- (a) the example is not exhaustive; and
  - (b) the example does not limit, and may extend, the meaning of the provision; and
  - (c) the example and the provision are to be read in the context of each other and of the other provisions of the Vehicle Standards, but, if the example and the provision as so read are inconsistent, the provision prevails.

## **Part 2—Application of the vehicle standards**

### **7—Application to vehicles and combinations on roads and road-related areas**

The Vehicle Standards apply to motor vehicles, trailers and combinations on roads and road-related areas.

## 8—Meaning of road

A road is an area that is open to or used by the public and is developed for, or has as one of its main uses, the driving or riding of motor vehicles.

## 9—Meaning of road-related area

A road-related area is any of the following:

- (a) an area that divides a road; or
- (b) a footpath or nature strip adjacent to a road; or
- (c) an area that is open to the public and is designated for use by cyclists or animals; or
- (d) any public place that is not a road and on which a motor vehicle may be driven, whether or not it is lawful to drive a motor vehicle there.

## 10—Vehicles to which the Vehicle Standards do not apply

The Vehicle Standards do not apply to:

- (a) a vehicle used only on a railway or tramway; or
- (b) a vehicle designed to be controlled by a person walking next to it; or
- (c) a vehicle propelled by a motor with a maximum power output of not over 200 watts; or
- (d) a motorised wheelchair that cannot travel at over 10 kilometres an hour; or
- (e) a vehicle or combination—
  - (i) that is being repaired, or is being tested in the course of being repaired, so it will comply with the Vehicle Standards; or
  - (ii) that is being driven or towed directly to a place where it is to be repaired so it will comply with the Vehicle Standards,

provided that the vehicle or combination is safe and will not endanger other road users if driven or towed on a road or road-related area.

## 11—Non-application of Vehicle Standards—exemption under other laws

- (1) A provision of the Vehicle Standards does not apply to a vehicle or combination if the vehicle or combination is exempt from:
  - (a) the provision under another law of this jurisdiction; or
  - (b) the corresponding provision of the law of another jurisdiction.
- (2) However, the vehicle or combination is exempt only if all conditions of the exemption (if any) are being complied with.

### Example—

An exemption permitting a greater dimension limit for a vehicle is subject to conditions about the route where, and times when, the vehicle is permitted to travel, and the escort vehicles required to accompany the vehicle. A relevant provision of the Vehicle Standards does not apply to the vehicle only if the conditions are complied with.



## 12—Non-application of Vehicle Standards—inconsistent ADR requirements

A provision of Parts 5 to 13 of the Vehicle Standards does not apply to a vehicle if:

- (a) the provision is inconsistent with a requirement of a second or third edition ADR applying to the vehicle; and
- (b) the vehicle complies with the requirement.

## 13—Non-application of Vehicle Standards—Motor Vehicle Standards Act approvals

A provision of Parts 5 to 13 of the Vehicle Standards does not apply to a vehicle if:

- (a) the vehicle does not comply with a requirement of an ADR applying to the vehicle; and
- (b) the provision of the Vehicle Standards corresponds to the requirement of the ADR; and
- (c) despite the non-compliance, approval has been given, under section 10A (2) or (3) of the *Motor Vehicle Standards Act 1989* of the Commonwealth, as in force from time to time, to place identification plates on vehicles of that type; and
- (d) the vehicle complies with the approval conditions (if any).

### Notes—

- 1 Section 10A (2) of the *Motor Vehicle Standards Act 1989* (Cwlth) deals with vehicles that do not comply with an ADR, but the non-compliance is only in minor and inconsequential respects.
- 2 Section 10A (3) of that Act deals with vehicles that do not comply with an ADR, and the non-compliance is not minor and inconsequential, but the vehicle will be safe to use if conditions are complied with.

## Part 3—Australian Design Rules

### Notes—

- 1 The Australian Design Rules (*ADRs*) are rules for designing and building vehicles. Imported vehicles must also comply with the ADRs. Certain ADRs are applied by the Vehicle Standards.  
  
The Vehicle Standards also apply certain other standards (adopted standards) that are intended to complement the ADRs.  
  
The ADRs do not cover:
  - vehicles built before 1969
  - combination of vehicles of any age
  - every safety feature for vehicles built between 1969 and 1988However, these matters are covered by provisions of the Vehicle Standards.
- 2 This Part applies the second and third edition ADRs to various vehicles.  
  
Under the Part, a vehicle that is subject to ADRs when it is built or imported generally remains subject to the ADRs throughout its life. However, a vehicle need not comply with a standard if the standard is replaced by, or inconsistent with, a later standard and the vehicle complies with the later standard. Older vehicles may, therefore, be fitted with any equipment allowed on newer vehicles.

Vehicles that are modified must continue to comply with the Vehicle Standards.

The following provisions of the Vehicle Standards extend the application of particular second or third edition ADRs to vehicles to which the ADRs are not expressed to apply:

rule 41 (4) (electrical wiring, connections and installations)

rule 119 (rear marking plates)

rule 136 (1) and (2) (braking system for prime mover in B-double)

rule 137 (braking system design for motor vehicles in road trains)

rule 138 (1) and (3) (braking system design for trailers in B-doubles or road trains)

rule 155 (1) and (2) (speed limiting).

The following provisions of the Vehicle Standards apply to a vehicle instead of the corresponding ADR requirement:

rule 44 (5) and (6) (window tinting)

rules 51 and 52 (tyre speed category requirements)

rule 115 (warning lights and signs on buses carrying children)

rule 118 (4) (display of certain lights and reflectors).

## **Division 1—Interpretation**

### **14—ADRs**

An Australian Design Rule (*ADR*) is a national standard.

### **15—National standards**

A national standard is a national standard under the *Motor Vehicle Standards Act 1989* of the Commonwealth, as in force from time to time.

### **16—References to national standards**

Unless the contrary intention appears, a reference in the Vehicle Standards to a national standard is a reference to the national standard as in force from time to time.

### **17—Second edition ADRs**

A second edition ADR is a national standard incorporated in the document described as the Australian Design Rules for Motor Vehicle Safety, Second Edition published by the Commonwealth Government.

### **18—Third edition ADRs**

A third edition ADR is a national standard incorporated in the document described as the Australian Design Rules for Motor Vehicles and Trailers, Third Edition published by the Commonwealth Government.

## **Division 2—Compliance with ADRs**

### **19—Compliance with second edition ADRs**

- (1) If a second edition ADR recommends that the ADR should apply to the design and construction of a vehicle, the vehicle must comply with the ADR.

- 
- (2) If a second edition ADR contains a requirement for a type of equipment fitted to a vehicle built on or after a stated time any equipment of the same type fitted to the vehicle after it is built must comply with:
    - (a) the requirement as in force when the vehicle was built; or
    - (b) if the requirement is amended after the vehicle is built and before the equipment is fitted—the requirement as in force:
      - (i) when the vehicle was built; or
      - (ii) when the equipment was fitted; or
      - (iii) at any time between when the vehicle was built and the equipment was fitted.
  - (3) However, a vehicle, or equipment fitted to a vehicle, need not comply with a recommendation or requirement of a second edition ADR if:
    - (a) the recommendation or requirement is replaced by, or is inconsistent with, a requirement of a third edition ADR applying to the vehicle or equipment; and
    - (b) the vehicle or equipment complies with the requirement of the third edition ADR.
  - (4) If a second edition ADR allows a vehicle built on or after a stated time to be fitted with equipment, a vehicle built before the time may also be fitted with the equipment.

## **20—Compliance with third edition ADRs**

- (1) If a third edition ADR applies to the design and construction of a vehicle, the vehicle must comply with the ADR.
- (2) If a third edition ADR contains a requirement for a type of equipment fitted to a vehicle built on or after a stated time, any equipment of the same type fitted to the vehicle after it is built must comply with:
  - (a) the requirement as in force when the vehicle was built; or
  - (b) if the requirement is amended after the vehicle is built and before the equipment is fitted—the requirement as in force:
    - (i) when the vehicle was built; or
    - (ii) when the equipment was fitted; or
    - (iii) at any time between when the vehicle was built and the equipment was fitted.
- (3) However, a vehicle, or equipment fitted to a vehicle, need not comply with a requirement of a third edition ADR if:
  - (a) the requirement is replaced by, or is inconsistent with, a requirement of a later version of the ADR applying to the vehicle or equipment; and
  - (b) the vehicle or equipment complies with the requirement of the later version.
- (4) If a third edition ADR allows a vehicle built on or after a stated time to be fitted with equipment, a vehicle built before the time may also be fitted with the equipment.

## 21—Exception to compliance with ADRs—vehicles that are not road vehicles

A vehicle need not comply with an ADR applied by rule 19 (1) or 20 (1) if a determination or declaration under section 5B of the *Motor Vehicle Standards Act 1989* of the Commonwealth, as in force from time to time, provides that the vehicle is not a road vehicle for that Act.

## 22—Exception to compliance with ADRs—Motor Vehicle Standards Act

- (1) A vehicle need not comply with an ADR applied by rule 19 (1) or 20 (1) if:
  - (a) despite non-compliance with the ADR, approval has been given, under section 10A (2) or (3) of the *Motor Vehicle Standards Act 1989* of the Commonwealth, as in force from time to time, to place identification plates on vehicles of that type; and
  - (b) the vehicle complies with the approval conditions (if any).

### Note—

See notes to rule 13.

- (2) A vehicle need not comply with an ADR applied by rule 19 (1) or 20 (1) if:
  - (a) the vehicle may be supplied to the market under section 14A (1) of the *Motor Vehicle Standards Act 1989* of the Commonwealth, as in force from time to time; and
  - (b) for a vehicle for which an approval has been given under that subsection—the vehicle complies with the approval conditions (if any).
- (3) A vehicle need not comply with an ADR applied by rule 19 (1) or 20 (1) if:
  - (a) the vehicle may be used in transport in Australia under section 15 (2) of the *Motor Vehicle Standards Act 1989* of the Commonwealth, as in force from time to time; and
  - (b) for a vehicle for which an approval has been given under that subsection—the vehicle complies with the approval conditions (if any).

## 23—Partial exception to compliance with ADRs—personally imported vehicles

- (1) In this rule:

***personally imported vehicle*** means a vehicle built after 1968 that is imported into Australia by a person who:

- (a) owned and used the vehicle for a continuous period of at least 3 months before it was imported into Australia; and
- (b) when the vehicle was imported into Australia, was:
  - (i) an Australian citizen or permanent resident or a person who had applied to become an Australian citizen or permanent resident; and
  - (ii) old enough to hold a licence or permit to drive the vehicle; and
- (c) within the previous year, had not imported into Australia another vehicle owned by the person.

- 
- (2) A personally imported vehicle must be fitted with:
- (a) seat belts that are as effective as seat belts that meet an Australian Standard or British Standard for seat belts as in force when this rule commenced; and
  - (b) seat belt anchorages that meet the number and location requirements of second or third edition ADR 5; and
  - (c) child restraint anchorages that meet the number, location, accessibility, thread size and form requirements of second edition ADR 34 or third edition ADR 5 or 34; and
  - (d) head restraints that meet the number, location and size requirements of second or third edition ADR 22.
- (3) However, a personally imported vehicle need only meet the requirements of an ADR mentioned in subrule (2) if the ADR recommends that it should apply, or applies, to a vehicle of the same type.
- (4) A personally imported vehicle need not otherwise comply with an ADR applied by rule 19 (1) or 20 (1).

## Part 4—Adopted standards

### 24—Adopted standards

An adopted standard is a standard, except a national standard, that is applied, adopted or incorporated by the Vehicle Standards.

**Example—**

Rule 62 (7) adopts Australian Standard AS 1906 Retro-reflective Materials and Devices for Road Traffic Control Purposes .

### 25—Reference to adopted standards

Unless the contrary intention appears, a reference in a rule or subrule to an adopted standard is a reference to the standard as in force at the commencement of the Vehicle Standards, or, if the provision in which reference appears commenced after the commencement of the Vehicle Standards, as in force at the commencement of that provision.

### 26—Exception to compliance with adopted standards

A vehicle need not comply with an adopted standard if:

- (a) the standard is replaced by, or is inconsistent with, a later version of the standard; and
- (b) the vehicle complies with the later version of the standard.

## Part 5—General safety requirements

**Note—**

For a vehicle to be operated safely, the vehicle needs to be properly designed to minimise the potential for accidents and harm to other road users.

This Part sets out various requirements covering the driver's view from a vehicle, the driver's control of a vehicle, protection of vehicle occupants and other road users, and other general safety features.

## **Division 1—All vehicles**

### **27—Steering**

- (1) A motor vehicle must have a right-hand drive.
- (3) A motor vehicle has a right-hand drive if the centre of at least 1 steering control of the vehicle is to the right of, or in line with, the centre of the vehicle.
- (4) A component of the steering system of a motor vehicle that is essential for effective steering of the vehicle must be built to transmit energy by mechanical means only.
- (5) Failure of a non-mechanical component of the steering system must not prevent effective steering of the vehicle.

### **28—Turning ability**

- (1) A motor vehicle must be able to turn in a circle not over 25 metres in diameter, measured by the outer edge of the tyre track at ground level.
- (2) The vehicle must be able to comply with subrule (1) whether it turns to the left or to the right.

### **29—Ability to travel backwards and forwards**

A motor vehicle with an unloaded mass over 450 kilograms must be able to be driven both backwards and forwards when the driver is in the normal driving position.

### **30—Protrusions**

- (1) An object fitted to a vehicle must be designed, built and fitted to the vehicle in a way that minimises the likelihood of injury to a person making contact with the vehicle.
- (2) However, subrule (1) does not apply to an object fitted to a vehicle if:
  - (a) the vehicle was designed before 1965 and the object was part of the design of the vehicle; or
  - (b) the object was fitted to the vehicle before 1965 in accordance with the law of the place where the object was fitted.

### **31—Driver's view and vehicle controls**

A motor vehicle must be built:

- (a) to allow the driver a view of the road and of traffic to the front and sides of the vehicle so the driver can drive the vehicle safely; and
- (b) with its controls located so the driver can drive the vehicle safely.

### **32—Seating**

A seat for a driver or passenger in a vehicle must be securely attached to the vehicle.

---

### 33—Mudguards and spray suppression

- (1) A vehicle must have firmly fitted:
  - (a) a mudguard for each wheel or for adjacent wheels; and
  - (b) for each axle group and single axle on a vehicle that is part of a B-double—spray suppression devices complying with Parts 1 and 2 of British Standard AU200–1984 Spray Reducing Devices for Heavy Goods Vehicle.
- (2) However, subrule (1) (a) does not apply to a vehicle if:
  - (a) the construction or use of the vehicle makes the fitting of mudguards unnecessary or impracticable and the vehicle is not driven or towed at a speed greater than 40 kilometres an hour; or
  - (b) the body or part of the body of the vehicle acts as a mudguard.

**Examples of vehicles to which subrule (2) (a) applies—**

- 1 Timber jinkers.
  - 2 Most road-making plant.
  - 3 Some agricultural equipment.
- (3) A mudguard fitted to a vehicle with a GVM over 4.5 tonnes must, when the wheels of the vehicle are in position to move straight ahead:
    - (a) reduce the danger of a person contacting the moving wheels; and
    - (b) for the rear wheels:
      - (i) cover the overall tyre width of the wheel or wheels to which it is fitted; and
      - (ii) be fitted so the height above ground level of the lowest edge of the rear of the mudguard is not over one-third of the horizontal distance between the edge and the centre of the rearmost axle.
  - (4) However, a mudguard may be up to:
    - (a) 230 millimetres above ground level; or
    - (b) on a vehicle built to be used off road—300 millimetres above ground level.
  - (5) The outside of a rear mudguard, except a mudflap, of a vehicle that can be seen from the rear of the vehicle must be coloured white or silver if the vehicle:
    - (a) is at least 2.2 metres wide; and
    - (b) has a body the vertical measurement of which is under 300 millimetres at the rear, measured from the lowest point of the body above ground level to the highest point; and
    - (c) is not fitted with rear marking plates in accordance with rule 119.
  - (6) For subrule (5) (a), the width of a vehicle is measured disregarding any anti-skid device mounted on wheels, central tyre inflation systems, lights, mirrors, reflectors, signalling devices and tyre pressure gauges.

### **34—Horns, alarms etc**

- (1) A motor vehicle must be fitted with at least 1 horn or other device that can give sufficient audible warning to other road users of the approach or position of the vehicle.
- (2) A motor vehicle must not be fitted with a device that can make a sound like the sound of a siren, bell, exhaust whistle, compression whistle or repeater horn.
- (3) However, subrule (2) does not apply to:
  - (a) a police vehicle; or
  - (b) an emergency vehicle; or
  - (f) a vehicle at least 25 years old that is fitted as a police or emergency vehicle if:
    - (i) the vehicle is only used for exhibition purposes; or
    - (ii) it is part of a collection of former police or emergency vehicles; or
  - (g) an anti-theft alarm if the alarm cannot be operated while the vehicle's ignition is on.
- (4) Also, a motor vehicle may be fitted with a device that emits a regular, intermittent sound while the vehicle is reversing or in reverse gear.
- (5) The device must not be louder than is necessary so the driver, and a person near the vehicle, can hear the device when it is operating.

### **35—Rear vision mirrors**

- (1) A rear vision mirror or mirrors must be fitted to a motor vehicle as required by this rule so that a driver of the vehicle can clearly see by reflection the road behind the vehicle and any following or overtaking vehicle.
- (2) At least 1 rear vision mirror must be fitted to:
  - (a) a car; and
  - (b) a motor trike with 2 front wheels; and
  - (c) a motor bike, or motor trike with 1 front wheel, built before July 1975.
- (3) At least 1 rear vision mirror must be fitted to each side of:
  - (a) a motor vehicle with a GVM over 3.5 tonnes; and
  - (b) a motor bike, or motor trike with 1 front wheel, built after June 1975.
- (4) A motor vehicle with a GVM not over 3.5 tonnes (except a motor vehicle mentioned in subrule (2) or (3)) must be fitted with:
  - (a) at least 1 rear vision mirror on the right side of the vehicle; and
  - (b) at least 1 rear vision mirror on the left side of the vehicle or inside the vehicle.
- (5) A rear vision mirror fitted to a motor vehicle with a GVM over 3.5 tonnes must not project over 150 millimetres beyond the widest part (excluding lights, signalling devices and reflectors) of the vehicle or combination.
- (6) However, the rear vision mirror may project not over 230 millimetres beyond the widest part of the vehicle or combination if it can fold to project not over 150 millimetres beyond the widest part.



**36—Rear vision mirrors—surfaces**

- (1) A rear vision mirror required to be fitted to the side of a motor vehicle with a GVM over 3.5 tonnes must have a reflecting surface of at least 150 square centimetres.
- (2) A rear vision mirror required to be fitted to the right side of a motor vehicle with a GVM over 3.5 tonnes must have a flat reflecting surface if:
  - (a) the motor vehicle has only 1 steering control; and
  - (b) the centre of the steering control is to the right of, or in line with, the centre of the motor vehicle.
- (3) The reflecting surface of the rear vision mirrors that are required to be fitted to a motor bike or moped must:
  - (a) each be of the same curvature; and
  - (b) if convex, be part of a notional sphere with a radius of at least 1.2 metres.

**37—Additional rear vision mirrors**

A motor vehicle may be fitted with additional rear vision mirrors or mirror surfaces that are flat or convex or a combination of flat and convex surfaces.

**38—Automatic transmission**

- (1) A motor vehicle fitted with an automatic transmission must have an engine starter mechanism that cannot operate when the transmission control is in a position to drive the vehicle.
- (2) A vehicle built after 1975 that is fitted with an automatic transmission must have an indicator in the driver's compartment showing the transmission control position.
- (3) Subrules (1) and (2) do not apply to a motor vehicle with less than 4 wheels.

**39—Diesel engines**

A motor vehicle propelled by a compression ignition engine (commonly known as a diesel engine) must be fitted with a device preventing the engine from being started accidentally or inadvertently.

**40—Bonnet securing devices**

- (1) A motor vehicle with a moveable body panel forward of the windscreen that covers an engine or luggage storage or battery compartment, must have a device to secure the panel.
- (2) However, if the panel opens from the front in a way that partly or completely obstructs the driver's forward view through the windscreen, the panel must have primary and secondary devices to secure the panel.

**41—Electrical wiring, connections and installations**

- (1) The wiring of electrical equipment of a vehicle, except the high tension ignition wiring, must:
  - (a) be supported at intervals of not over 600 millimetres, unless the vehicle is a pole-type trailer with a pole with an adjustable length, or an extendible trailer; and

- (b) be insulated at each of its joints; and
  - (c) be located where it cannot:
    - (i) become overheated; or
    - (ii) contact moving parts; or
    - (iii) come near enough to the fuel system to be a fire hazard; and
  - (d) be protected from chafing.
- (2) The electrical connectors between motor vehicles and trailers, for operation of the vehicle lights required by the Vehicle Standards, must comply with Australian Standard AS 2513–1982 Electrical Connections for Trailer Vehicles.
- (3) A trailer must be equipped with an electrical conductor, independent of the trailer coupling, that provides a return path between the electrical circuits of the trailer and towing vehicle.
- (4) The electrical wiring, connections and installations of a semi-trailer, dog trailer or converter dolly used in a road train over 19 metres long after June 1998 must comply with third edition ADR 63, whether or not it was built before the date stated in the ADR for vehicles of that type.

#### **42—Television receivers and visual display units**

- (1) A television receiver or visual display unit must not be installed in a vehicle so any part of the image on the screen is visible to the driver from the normal driving position.
- (2) However, subrule (1) does not apply to:
- (a) a television receiver or visual display unit that cannot be operated when the vehicle is moving; or
  - (b) a driver's aid in any vehicle or a destination sign in a bus.

##### **Examples of driver's aids—**

- 1 Closed-circuit television security cameras.
  - 2 Dispatch systems.
  - 3 Navigational or intelligent highway and vehicle system equipment.
  - 4 Rearview screens.
  - 5 Ticket-issuing machines.
  - 6 Vehicle monitoring devices.
- (3) A television receiver, or visual display unit, and its associated equipment in a vehicle must be securely mounted in a position that:
- (a) does not obscure the driver's view of the road; and
  - (b) does not impede the movement of a person in the vehicle.

#### **43—Windscreens and windows**

- (1) Transparent material used in a windscreen, window, or an interior partition, of a motor vehicle must be of approved material if:
- (a) the vehicle was built after June 1953; or

(b) the material was first fitted to the vehicle after June 1953.

(2) In this rule:

**approved material** means material with the same characteristics as material mentioned in any of the following standards:

- Australian Standard AS R1–1965 Safety Glass for Land Transport
- Australian Standard AS R1–1968 Safety Glass for Land Transport
- Australian Standard AS 2080–1977 Safety Glass for Vehicles
- British Standard BS 857:1967 Specification for Safety Glass for Land Transport
- British Standard BS 5282:1975 Road Vehicle Safety Glass
- British Standard BS AU178: 1980 Road Vehicle Safety Glass
- Japanese Industrial Standard JIS R 3211–1979 Safety Glasses for Road Vehicles
- American National Standard ANSI Z26.1–1980 Safety Code for Safety Glazing Materials for Glazing Motor Vehicles Operating on Land Highway.

**transparent material** does not include any coating added to the windscreen, window or partition after its manufacture.

#### 44—Window tinting

- (1) Glazing used in a windscreen of a motor vehicle must have a luminous transmittance of at least:
  - (a) for a motor vehicle built after 1971—75%; or
  - (b) for another motor vehicle—70%.
- (2) Windscreen glazing of a motor vehicle must not be coated in a way that reduces its luminous transmittance.
- (3) However, subrules (1) and (2) do not apply to the greater of the following areas of a windscreen:
  - (a) the area above the highest point of the windscreen that is swept by a windscreen wiper;
  - (b) the upper 10% of the windscreen.
- (4) Glazing used in a window or interior partition of a motor vehicle must have a luminous transmittance of at least 70%.
- (5) Glazing behind the rear of the driver's seat may be coated to achieve a luminous transmittance of not less than 35%.
- (6) Glazing in a side window forward of the rear of the driver's seat may be coated to achieve a luminous transmittance of not less than 70% or, if another law of this jurisdiction allows a lesser luminous transmittance, the greater of:
  - (a) the lesser luminous transmittance allowed under the other law; and
  - (b) 35%.

- (7) Glazing that has been coated to reduce its luminous transmittance must not have a reflectance of over 10%.
- (8) The luminous transmittance requirements in subrules (5) and (6) apply to a vehicle instead of the corresponding requirements in the relevant ADR.
- (9) In this rule:

*glazing* means material fitted to the front, sides, rear or interior of a vehicle, through which the driver can see the road, but does not include a coating added after manufacture of the material.

*luminous transmittance*, for glazing, means the amount of light that can pass through the glazing as a percentage of the amount of light that would be transmitted if the glazing were absent.

#### **45—Windscreen wipers and washers**

- (1) A motor vehicle with 3 or more wheels that is fitted with a windscreen must be fitted with at least 1 windscreen wiper unless a driver in a normal driving position can obtain an adequate view of the road ahead of the motor vehicle without looking through the windscreen.
- (2) At least 1 windscreen wiper fitted to the motor vehicle must:
  - (a) be able to remove moisture from the part of the windscreen in front of the driver to allow the driver an adequate view of the road ahead of the motor vehicle when the windscreen is wet; and
  - (b) be able to be operated from a normal driving position; and
  - (c) for a motor vehicle built after 1934—continue to operate until the wiper is switched off; and
  - (d) for a motor vehicle built after 1959 the driving position of which is nearer one side of the vehicle than the other:
    - (i) be able to remove moisture from the part of the windscreen in front of the driver, and a corresponding part of the windscreen on the other side of the centre of the motor vehicle, to allow the driver an adequate view of the road ahead of the motor vehicle when the windscreen is wet; and
    - (ii) if the windscreen wipers are operated by engine manifold vacuum—be provided with a vacuum reservoir or pump to maintain the efficient operation of the wiper or wipers while the vehicle is in motion.
- (3) If the motor vehicle was built after 1982 and has a GVM over 4.5 tonnes, it must also be fitted with a windscreen washer that can direct water onto the windscreen within the area swept by a windscreen wiper so the wiper can spread the water to all of the area swept by the wiper.

**Note—**

The ADRs require certain vehicles with a GVM not over 4.5 tonnes to be fitted with a windscreen washer.

- (4) The windscreen washer must be able to be operated from a normal driving position.

**46—Wheels and tyres—size and capacity**

The wheels and tyres fitted to an axle of a vehicle must be of sufficient size and capacity to carry the part of the vehicle's gross mass transmitted to the ground through the axle.

**47—Pneumatic tyres generally**

A vehicle built after 1932 must be fitted with pneumatic tyres.

**48—Pneumatic tyres—carcass construction**

- (1) A vehicle with a GVM not over 4.5 tonnes must not have pneumatic tyres of different carcass construction fitted to the same axle, but the tyres may have different cord materials and a different number of plies.
- (2) However, subrule (1) does not apply to a tyre being used in an emergency as a temporary replacement for a tyre complying with the subrule.

**49—Pneumatic tyres—size and capacity**

The size and capacity of a pneumatic tyre to be fitted to a vehicle must be decided using a cold inflation pressure that is not more than the lesser of:

- (a) the pressure recommended by the tyre manufacturer; and
- (b) a pressure of:
  - (i) for a radial ply tyre—825 kilopascals; or
  - (ii) for another tyre—700 kilopascals.

**50—Tyres—defects**

A tyre fitted to a vehicle must be free of any apparent defect that could make the vehicle unsafe.

**51—Tyres for use on vehicles with GVM over 4.5 tonnes**

- (1) A tyre fitted to a vehicle with a GVM over 4.5 tonnes must be suitable for road use at the lesser of:
  - (a) 100 kilometres an hour; and
  - (b) the vehicle's top speed.
- (2) This rule applies to a vehicle instead of the tyre speed category requirements in the relevant ADR.

**52—Tyres—manufacturer's rating**

- (1) This rule applies to a motor vehicle if the vehicle:
  - (a) has 4 or more wheels; and
  - (b) was built after 1972; and
  - (c) has a GVM not over 4.5 tonnes.

- (2) However, this rule does not apply to a tyre if the tyre:
- (a) is recommended by the vehicle builder as suitable for limited use on the vehicle in special circumstances at a speed less than the speed applying to the vehicle under subrule (3); or
  - (b) is being used in an emergency as a temporary replacement for a tyre complying with this rule.
- (3) A tyre fitted to a motor vehicle must, when first manufactured, have been rated by the tyre manufacturer as suitable for road use at the lesser of:
- (a) a speed of at least:
    - (i) for a car with special features for off-road use—140 kilometres an hour; or
    - (ii) for another car—180 kilometres an hour; or
    - (iii) for another motor vehicle—120 kilometres an hour; and
  - (b) the vehicle's top speed.

**Example—**

Example for paragraph (a) (i)

A four-wheel drive vehicle.

- (4) This rule applies to a vehicle instead of the tyre speed category requirements in the relevant ADR.

### **53—Retreads**

- (1) A tyre that is retreaded before the commencement of this rule must not be used on a vehicle if:
- (a) Australian Standard AS 1973–1976 Retreaded Pneumatic Passenger Car and Light Truck Tyre or Australian Standard AS 1973–1985 Retreaded Pneumatic Passenger and Light Truck Tyre applies to the tyre; and
  - (b) the tyre was retreaded after publication of the Australian Standard; and
  - (c) the tyre was not retreaded in accordance with Australian Standard AS 1973–1976 Retreaded Pneumatic Passenger Car and Light Truck Tyre, Australian Standard AS 1973–1985 Retreaded Pneumatic Passenger and Light Truck Tyre or Australian Standard AS 1973–1993 Pneumatic Tyres—Passenger Car, Light Truck and Truck/Bus—Retreading and Repair Processes.
- (2) A tyre that is retreaded after the commencement of this rule must not be used on a vehicle if:
- (a) Australian Standard AS 1973–1993 Pneumatic Tyres—Passenger Car, Light Truck and Truck/Bus—Retreading and Repair Processes applies to the tyre; and
  - (b) the tyre was not retreaded in accordance with the Australian Standard.

**Note—**

The Australian Standards mentioned in this rule require various markings on retreaded tyres. These may include a speed rating less than the rating originally marked on the tyre.

**54—Tyre tread**

- (1) A tyre on a motor vehicle must not have cleats or other gripping devices that could damage road surfaces.
- (2) Except at tread wear indicators, a tyre fitted to the vehicle must have a tread pattern at least 1.5 millimetres deep in a band that runs continuously:
  - (a) across:
    - (i) for a vehicle with a GVM over 4.5 tonnes—at least 75% of the tyre width that normally comes into contact with the road; or
    - (ii) for another vehicle—the tyre width that normally comes into contact with the road; and
  - (b) around the whole circumference of the tyre.
- (3) A vehicle must not be fitted with a tyre that has been treated by recutting or regrooving the tread rubber, unless the tyre was:
  - (a) constructed with an extra thickness of rubber designed for recutting or regrooving; and
  - (b) labelled to indicate the construction.

**Division 2—Additional requirements for motor bikes****55—Steering gear and handlebars**

- (1) The handlebars on a motor bike must extend at least 250 millimetres, but not over 450 millimetres, on each side of the centre line of the vehicle.
- (2) In taking a measurement for subrule (1), mirrors and lights mounted on the handlebars of the motor bike are disregarded.
- (3) The lowest part of the hand grip on the handle bars must not be higher than 380 millimetres above the attachment point of the handlebars to the motor bike.
- (4) Hand grips on the handle bars must be fitted symmetrically.
- (5) If a motor bike has the head stem as the steering pivot point, the horizontal distance from the midpoint between the head stem bearings to the centre of the front wheel must not be over 550 millimetres.

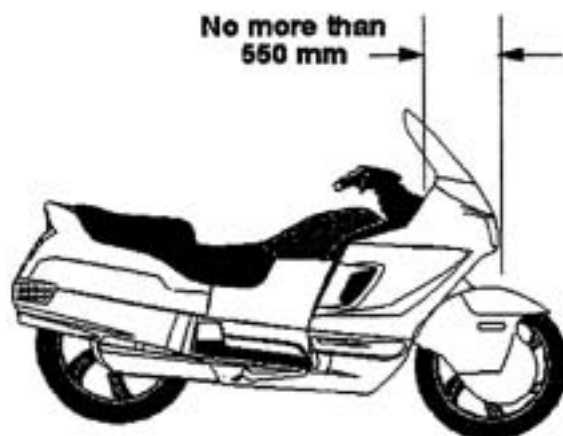

Maximum horizontal distance from midpoint between head stem bearings of motor bike to centre of front wheel

### 56—Foot rests

A motor bike must be fitted with foot rests for the driver, and for any passenger for whom a seating position is provided.

### 57—Chain guards

- (1) If the engine power of a motor bike is transmitted to the rear wheel by a chain, the driver and any passenger must be protected from the front sprocket and at least the upper part of the chain by:
  - (a) the frame or equipment of the motor bike; or
  - (b) a chain guard.
- (2) A chain guard must cover the chain to a point:
  - (a) at least 300 millimetres to the rear of the rearmost foot rest; or
  - (b) above the centre of the rear drive sprocket.

### 57A—Sidecars

A sidecar on a motor bike must be positioned on the left hand side of the motor bike.

## Part 6—Vehicle marking

### Note—

This Part contains requirements for a vehicle that help to identify the vehicle and, if the vehicle is unusually long, to warn other motorists.

### 58—Vehicle and engine identification numbers

- (1) In this rule:

*number* includes letter.
- (2) A motor vehicle must have an individual engine identification number clearly stamped, embossed or otherwise permanently marked on it.
- (3) A motor vehicle built after 1930 must have the engine identification number on its engine block or the main component of its engine.



- (4) A vehicle must have an individual vehicle identification number clearly stamped, embossed or otherwise permanently marked on a substantial part of its frame or chassis.
- (5) A vehicle or engine identification number must be located where a person can read it easily without having to use tools to remove a part of the vehicle that would otherwise obstruct the person's view.

### **59—White or silver band on certain vehicles**

- (1) This rule applies to a vehicle that:
  - (a) is at least 2.2 metres wide; and
  - (b) has a body with a vertical measurement under 300 millimetres at the rear, measured from the lowest point of the body above ground level to the highest point; and
  - (c) is not fitted with rear marking plates in accordance with rule 119.
- (2) For subrule (1) (a), the width of a vehicle is measured disregarding any anti-skid device mounted on wheels, central tyre inflation systems, lights, mirrors, reflectors, signalling devices and tyre pressure gauges.
- (3) The vehicle must have a white or silver band at least 75 millimetres high across the full width of the rearmost part of the body of the vehicle.

### **60—Warning signs for combinations over 22 metres long**

- (1) The following vehicles must display road train warning signs complying with this rule and rule 62:
  - (a) a combination over 36.5 metres long;
  - (b) a road train over 30 metres, but not over 36.5 metres, long that includes 1 or more dog trailers.
- (2) The following vehicles must display road train warning signs, or a long vehicle warning sign, complying with this rule and rule 62:
  - (a) a road train over 22 metres, but not over 30 metres, long that includes 1 or more dog trailers;
  - (b) a road train over 22 metres, but not over 36.5 metres, long that does not include a dog trailer.
- (3) Another combination over 22 metres, but not over 36.5 metres, long must display a long vehicle warning sign complying with this rule and rule 62.
- (4) Subrules (1), (2) and (3) do not apply to the extent of any inconsistency with the conditions of an oversize or overmass vehicle exemption that applies to the combination (see section 115 of the *Road Traffic Act 1961* relating to oversize or overmass vehicle exemptions).
- (5) Road train warning signs must be used in pairs and fitted horizontally, one at the front and the other at the rear of the combination.
- (6) A long vehicle warning sign must be fitted horizontally at the rear of the combination.

## 61—Warning signs not to be displayed on other vehicles

- (1) A road train warning sign must not be displayed on a vehicle unless the vehicle is part of a combination or road train mentioned in rule 60 (1) or (2).
- (2) A long vehicle warning sign must not be displayed on a vehicle unless the vehicle is a part of a combination or road train mentioned in rule 60 (2) or (3).

## 62—Specifications for warning signs

- (1) A road train or long vehicle warning sign must be manufactured in 1 or 2 parts from sheet steel 0.8 millimetres thick or another material of at least the same stiffness, unless it is designed to be fixed to a vehicle using an adhesive.
- (2) The warning sign must be at least 1.02 metres wide and at least 250 millimetres high.
- (3) A road train warning sign must display the words "road train", and a long vehicle warning sign must display the words "long vehicle", in black capital letters at least 180 millimetres high in typeface Series B (N) that complies with Australian Standard AS 1744 Forms of Letters and Numerals for Road Signs.
- (4) If the warning sign is in 2 parts, one word of the expression "road train" or "long vehicle" must be on one part and the other word of the expression must be on the other part.
- (5) The warning sign must display the sign manufacturer's name or logo, and the brand and class of retro-reflective material used, in block letters not over 10 millimetres high.
- (6) The warning sign must have a black border.
- (7) The warning sign must be coated with yellow retro-reflective material of class 1 or 2 that meets Australian Standard AS 1906 Retro-reflective Materials and Devices for Road Traffic Control Purposes.
- (8) The warning sign must be fitted so:
  - (a) no part of the sign is:
    - (i) over 1.8 metres above ground level; or
    - (ii) under 500 millimetres above ground level; and
  - (b) if the sign is in 2 parts—the parts are fitted at the same height above ground level.

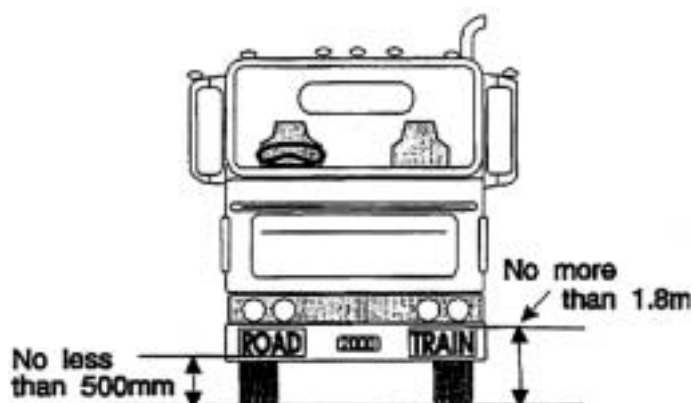

Positioning of a warning sign

### **63—Left-hand drive signs**

- (1) This rule applies to a motor vehicle with a GVM over 4.5 tonnes that has the centre of a steering control to the left of the centre of the vehicle.
- (2) The vehicle must display the words "left hand drive" on the rear of the vehicle.
- (3) The words must be in letters at least 75 millimetres high, and in a colour contrast with the background to the words.

## **Part 7—Vehicle configuration and dimensions**

### **Note—**

This Part sets out various requirements covering the suspension on vehicles and size limits for single vehicles and combinations of vehicles, so that they can be operated safely with other traffic, without taking up too much road space or damaging the road and structures on the road.

Generally, the limits in this Part apply to a vehicle and any load it may be carrying.

Specific requirements for loaded vehicles are covered by other laws.

### **Division 1—Axles**

#### **64—Axle configuration**

- (1) A motor vehicle, except an articulated bus, must have only:
  - (a) 1 axle group, or single axle, towards the front of the vehicle; and
  - (b) 1 axle group, or single axle, towards the rear of the vehicle.
- (2) An articulated bus must have:
  - (a) on its front section:
    - (i) only 1 axle group, or single axle, towards the front of the section;  
and
    - (ii) only 1 axle group, or single axle, towards the rear of the section; and
  - (b) on another section—only 1 axle group or single axle.
- (3) A trailer must have only:
  - (a) 1 axle group or single axle; or
  - (b) 2 axle groups, 2 single axles, or 1 axle group and single axle, in the following configuration:
    - (i) 1 axle group, or single axle, towards the front of the vehicle, with all the wheels on the axle group or single axle connected to the steering mechanism for that part of the trailer;
    - (ii) 1 axle group, or single axle, towards the rear of the vehicle.
- (4) A semi-trailer that is extendible, or is fitted with sliding axles, must:
  - (a) have a securing device that:
    - (i) can securely fix the extendible part or sliding axles to the rest of the vehicle in any position of adjustment provided; and

- (ii) is located in a position that can prevent accidental or inadvertent release, if the device is mounted on the chassis of the vehicle; and
  - (iii) is fitted with a visible or audible warning system to indicate to a person standing beside the vehicle that the device is not engaged; and
  - (iv) is fitted with a way of preventing loss of air from the air brake supply, if the device uses air from the brake system and fails in a way allowing air to escape; and
  - (v) is held in the applied position by direct mechanical action without the intervention of an electric, hydraulic or pneumatic device; and
- (b) be built so the adjustable parts of the vehicle remain connected if the securing device fails.
- (5) The axle groups in a B-double with two tri-axle groups must be positioned so that the following formulae are complied with:

$$X - Y \geq 1$$

$$Y - X \geq 1.3$$

where

**X** means the distance in metres (measured to the nearest tenth of a metre) between the centres of the closest axles in the second and third axle groups of the B-double;

**Y** means the distance in metres (measured to the nearest tenth of a metre) between the centres of the closest axles in the third and fourth axle groups of the B-double.

## **65—Relation between axles in axle group**

- (1) The axles in an axle group, except a twinsteer axle group, fitted to a vehicle with a GVM over 4.5 tonnes must relate to each other through a load-sharing suspension system.
- (2) In this rule:
- load-sharing suspension system** means an axle group suspension system that:
- (a) is built to divide the load between the tyres on the group so that no tyre carries a mass over 10% more than the mass that it would carry if the load were divided equally; and
  - (b) has effective damping characteristics on all axles of the group.

## **Division 2—Dimensions**

### **66—Width**

- (1) A vehicle must not be over 2.5 metres wide.
- (2) For subrule (1), the width of a vehicle is measured without taking into account any anti-skid device mounted on wheels, central tyre inflation systems, lights, mirrors, reflectors, signalling devices and tyre pressure gauges.

### **67—Length of single motor vehicles**

- (1) A motor vehicle, except an articulated or controlled access bus, must not be over 12.5 metres long.

- (2) A controlled access bus must not be over 14.5 metres long.
- (3) An articulated bus must not be over 18 metres long.

### 68—Length of single trailers

- (1) On a semi-trailer or a dog trailer:
  - (a) the distance between the point of articulation at the front of the trailer and the rear overhang line must not be over 9.5 metres; and
  - (b) the distance between the point of articulation at the front of the trailer and the rear of the trailer must not be over 12.3 metres.
- (2) A projection forward of the point of articulation at the front of a semi-trailer must be contained within a radius of 1.9 metres from the point of articulation.
- (3) If a semi-trailer has 2 or more points of articulation at the front of the trailer, it must comply with subrules (1) and (2) when measured at one of the points.
- (4) A trailer built to carry cattle, sheep, pigs or horses on 2 or more partly or completely overlapping decks must not have over 12.5 metres of its length available for the carriage of animals.
- (5) For subrule (4), the length available for the carriage of animals on a trailer is measured from the inside of the front wall or door of the trailer to the inside of the rear wall or door of the trailer, with any intervening partitions disregarded.

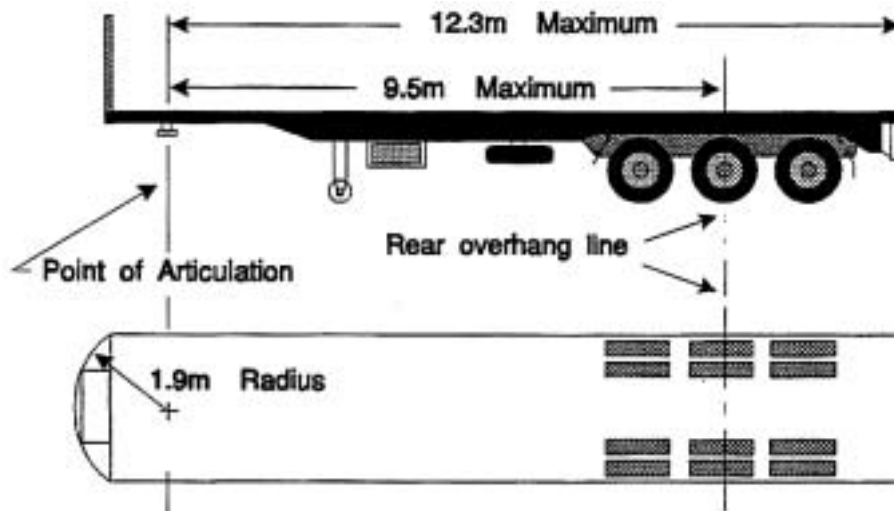

Maximum dimensions of a semi-trailer

### 69—Length of combinations

- (1) A combination must not be over:
  - (a) for a B-double—25 metres long; and
  - (b) for a road train—53.5 metres long; and
  - (c) for a combination, except a road train, designed to carry vehicles on 2 or more partly or completely overlapping decks—25 metres long; and
  - (d) for another combination—19 metres long.

- (2) In a B-double built to carry cattle, sheep, pigs or horses, the 2 semi-trailers must not have over 18.8 metres of their combined length available for the carriage of animals.
- (3) For subrule (2), the length available for the carriage of animals on a trailer is measured from the inside of the front wall or door of the trailer to the inside of the rear wall or door of the trailer, with any intervening partitions disregarded.

## **70—Rear overhang**

- (1) The rear overhang of a semi-trailer, or dog trailer consisting of a semi-trailer and converter dolly, must not exceed the lesser of:
  - (a) 60% of the distance between the point of articulation at the front and the rear overhang line; and
  - (b) 3.7 metres.
- (2) A semi-trailer with 2 or more points of articulation at the front must comply with subrule (1) when measured at the same point used for measurement for compliance with rule 68 (3).
- (3) The rear overhang of a trailer with only 1 axle group or single axle (except a semi-trailer) must not exceed the lesser of:
  - (a) the length of the load carrying area ahead of the rear overhang line; and
  - (b) 3.7 metres.
- (4) The rear overhang of a vehicle not mentioned in subrule (1) or (3) must not exceed the lesser of:
  - (a) 60% of the distance between the centre of the front axle and the rear overhang line; and
  - (b) 3.7 metres.
- (5) In this rule:

*load carrying area*, in relation to a trailer, means the part of the trailer on which a load may safely be carried, and may include the drawbar of the trailer.

## **71—Trailer drawbar length**

- (1) The distance between the coupling pivot point on the drawbar of a dog trailer, and the centre line of the front axle group or of the front single axle of the trailer, must:
  - (a) not be over 5 metres; and
  - (b) not be under 3 metres, if the trailer is used in a road train over 19 metres long.

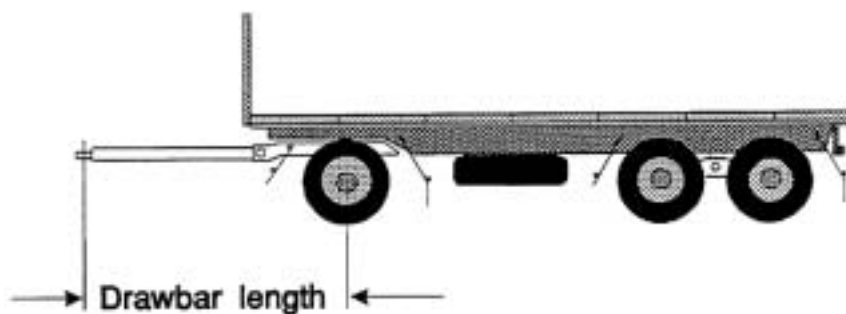

Length of a drawbar on a dog trailer

- (2) The distance between the coupling pivot point on a drawbar, and the centre line of the axle group or single axle on a trailer with only 1 axle group or single axle (except a semi-trailer) must not be over 8.5 metres.

## 72—Height

- (1) A vehicle must not be over 4.3 metres high.
- (2) However:
- a vehicle built to carry cattle, sheep, pigs or horses must not be over 4.6 metres high; and
  - a double-deck bus must not be over 4.4 metres high.

## 73—Ground clearance

- (1) In this rule:

**ground clearance**, of a vehicle, means the minimum distance to the ground from a point on the underside of the vehicle, except a point on a tyre, wheel, wheel hub, brake backing plate or flexible mudguard or mudflap of the vehicle.

- (2) A motor vehicle or combination must have a ground clearance of:
- at least 100 millimetres at any point within 1 metre of an axle; and
  - at least one-thirtieth of the distance between the centres of adjacent axles at the midpoint between them; and
  - at any other point—at least the distance that allows the vehicle or combination to pass over a peak in the road with a gradient on either side of 1:15, if the wheels of 1 axle of the vehicle or combination are on the slope on one side of the peak and the wheels of the next axle are on the slope on the other side.

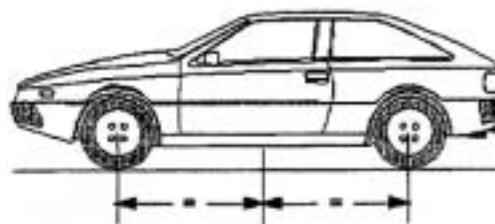

Ground clearance at the mid-point between 2 axles

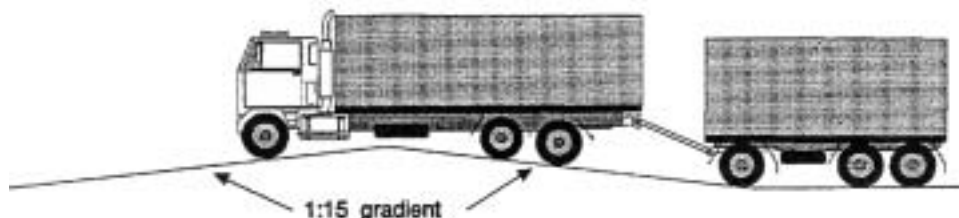

Ground clearance over a peak in the road

- (3) However, subrule (2) does not apply to:
- a motor vehicle with less than 4 wheels; or

- (b) a combination that includes a motor vehicle with less than 4 wheels.

## Part 8—Lights and reflectors

### Note—

This Part deals with how the lights on a vehicle must be fitted and work so that the driver can see the road, pedestrians and other vehicles at night, and can signal to others.

Other laws provide for when certain lights must be switched on.

In this Part, the description "yellow" is used as a more modern term, instead of the description "amber" which is used in earlier legislation and some ADRs.

## Division 1—General requirements for lights

### 74—Certain requirements apply only at night

The requirements of this Part for a light, except a brake or direction indicator light, to be visible over a stated distance apply only at night.

### 75—Prevention of glare

A light, except a high-beam headlight, fitted to a vehicle must be built and adjusted to provide the necessary amount of light, without dazzling the driver of another vehicle approaching, or being approached by, the vehicle.

### 76—Pairs of lights

- (1) If lights are required under the Vehicle Standards to be fitted to a vehicle in pairs:
- (a) a light must be fitted on each side of the longitudinal axis of the vehicle; and
  - (b) the centre of each light in a pair must be the same distance from the longitudinal axis of the vehicle; and
  - (c) the centre of each light in a pair must be at the same height above ground level; and
  - (d) each light in a pair must project approximately the same amount of light of the same colour.
- (2) Subrule (1) applies to a motor bike with an attached sidecar as if the sidecar were not attached.

## Division 2—Headlights

### 77—Headlights to be fitted to vehicles

- (1) A motor vehicle must be fitted with:
- (a) 1 low-beam headlight if it is a moped, motor bike, or motor trike with 1 front wheel; or
  - (b) a pair of low-beam headlights if it has 4 or more wheels or is a motor trike, except a moped, with 2 front wheels.



- (2) If a motor vehicle built after 1934 can travel at over 60 kilometres an hour:
  - (a) each low-beam headlight mentioned in subrule (1) must be able to work in the high-beam position; or
  - (b) the vehicle must be fitted with:
    - (i) 1 headlight that can work in the high-beam position if the vehicle is required to have 1 low-beam headlight; or
    - (ii) a pair of headlights that can work in the high-beam position.
- (3) A motor bike may be equipped with a headlight modulation system that:
  - (a) varies the brightness of its high-beam headlight or low-beam headlight, but not both, at a rate of at least 200 and at most 280 flashes a minute; and
  - (b) is designed to operate only in the daylight.
- (4) Additional headlights may be fitted to a motor bike or motor trike, or a motor vehicle with 4 or more wheels that was built before 1970.
- (5) Additional pairs of headlights may be fitted to a motor vehicle with 4 or more wheels that was built after 1969.

#### **78—How headlights are to be fitted**

- (1) The centres of low-beam headlights fitted as a pair on a motor vehicle with 4 or more wheels must be at least 600 millimetres apart.
- (2) However, subrule (1) does not apply to a motor vehicle built before 1970 if the centres of its low-beam headlights:
  - (a) were under 600 millimetres apart when the vehicle was built; and
  - (b) are not nearer than they were when the vehicle was built.
- (3) Each low-beam headlight of a pair on a motor trike (except a moped) with 2 front wheels must not be over 400 millimetres from the nearer side of the vehicle.
- (4) The centre of a low-beam headlight fitted to a motor vehicle built after June 1953 must be:
  - (a) at least 500 millimetres above ground level; and
  - (b) not over 1.4 metres above ground level.

#### **79—How single headlights are to be fitted**

- (1) A motor bike or trike with a single headlight fitted must have the light fitted in the centre.
- (2) Subrule (1) applies to a motor bike with an attached sidecar as if the sidecar were not attached.

#### **80—How additional headlights are to be fitted**

If 2 or more additional headlights are fitted to a motor vehicle with 4 or more wheels, the additional headlights must as far as possible be fitted in pairs.

## 81—Performance of headlights

- (1) When on, a headlight, or additional headlight, fitted to a vehicle must:
  - (a) show only white light; and
  - (b) project its main beam of light ahead of the vehicle.
- (2) Headlights must be fitted to a vehicle so their light does not reflect off the vehicle into the driver's eyes.

## 82—Effective range of headlights

- (1) This rule applies to a headlight that is on at night.
- (2) A low-beam headlight must illuminate the road ahead of the vehicle for at least 25 metres.
- (3) A high-beam headlight must illuminate the road ahead of the vehicle for at least 50 metres.
- (4) However, a low-beam headlight fitted to a motor vehicle built before 1931, or a moped, need only illuminate the road ahead of the vehicle for 12 metres.

## 83—Changing headlights from high-beam to low-beam position

- (1) A motor vehicle built after 1934 that can travel at over 60 kilometres an hour must be fitted with:
  - (a) a dipping device enabling the driver in the normal driving position:
    - (i) to change the headlights from the high-beam position to the low-beam position; or
    - (ii) simultaneously to switch off a high-beam headlight and switch on a low-beam headlight; and
  - (b) for a vehicle built after June 1953—a device to indicate to the driver that the headlights are in the high-beam position.
- (2) A headlight fitted to a vehicle not fitted with a dipping device mentioned in subrule (1) (a) must operate in the low-beam position.
- (3) When a headlight fitted to a vehicle is switched to the low-beam position, any other headlight on the vehicle must operate only in the low-beam position or be off.

## Division 3—Parking lights

### 84—Parking lights

- (1) A motor vehicle built after June 1953 must be fitted with:
  - (a) a pair of parking lights if it is a motor trike with 2 front wheels (except a moped) or a motor vehicle with 4 or more wheels; or
  - (b) at least 1 parking light if it is a motor bike with an attached sidecar, or a motor trike with 1 front wheel, (except a moped).
- (2) A pair of parking lights fitted to a motor vehicle with 4 or more wheels must be fitted with the centre of each light:
  - (a) at least 600 millimetres from the centre of the other light; and

- (b) not over 510 millimetres from the nearer side of the vehicle.
- (3) However, a pair of parking lights fitted to a motor vehicle under 1300 millimetres wide may be fitted with the centre of each light not under 400 millimetres from the centre of the other light.
- (4) A parking light fitted to a motor trike with 2 front wheels must not be over 400 millimetres from the nearer side of the vehicle.
- (5) A parking light fitted to a motor bike with a sidecar must be fitted not over 150 millimetres from the side of the sidecar furthest from the motor bike.
- (6) When on, a parking light must:
- show a white or yellow light visible 200 metres from the front of the vehicle; and
  - not use over 7 watts power.
- (7) A parking light fitted to a motor vehicle built after 1969 must be wired so the parking light is on when a headlight on the vehicle is on.
- (8) A parking light fitted to a sidecar attached to a motor bike must be wired to operate when a headlight, tail light or parking light on the motor bike is on.
- (9) For subrule (3), the width of a vehicle is measured disregarding any anti-skid device mounted on wheels, central tyre inflation systems, lights, mirrors, reflectors, signalling devices and tyre pressure gauges.

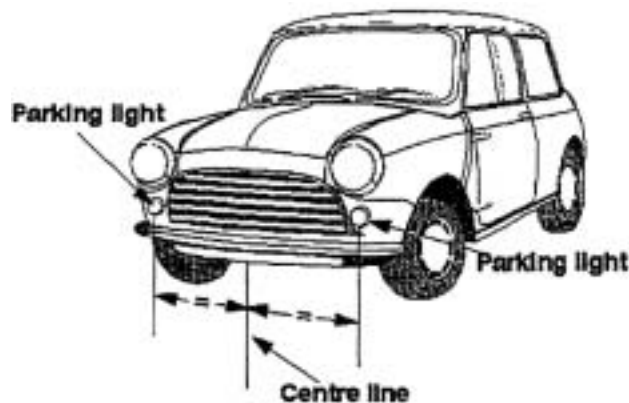

Location of parking lights on a vehicle

## Division 4—Daytime running lights

### 85—Daytime running lights

- (1) A pair of daytime running lights may be fitted to a motor vehicle.
- (2) A pair of daytime running lights fitted to a vehicle with 4 or more wheels must be fitted with the centre of each light:
- at least 600 millimetres from the centre of the other light; and
  - not over 510 millimetres from the nearer side of the vehicle.
- (3) However, a pair of daytime running lights fitted to a motor vehicle under 1300 millimetres wide may be fitted with the centre of each light not under 400 millimetres from the centre of the other light.

- (4) When on, a daytime running light must:
- (a) show a white or yellow light visible from the front of the vehicle; and
  - (b) not use over 25 watts power.

**Note—**

The third edition ADRs only allow white daytime running lights.

- (5) Daytime running lights must be wired so they are off when a headlight, except a headlight being used as a flashing signal, is on.
- (6) For subrule (3), the width of a vehicle is measured disregarding any anti-skid device mounted on wheels, central tyre inflation systems, lights, mirrors, reflectors, signalling devices and tyre pressure gauges.

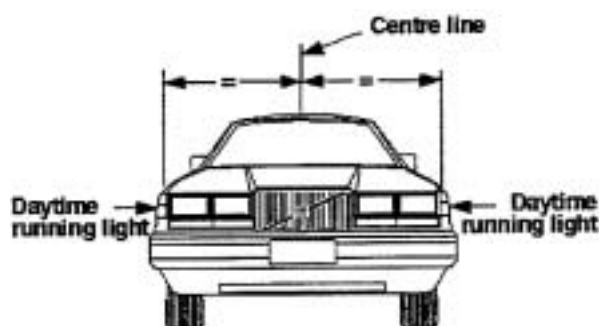

Location of daytime running lights on a vehicle

## **Division 5—Tail lights**

### **86—Tail lights generally**

- (1) A vehicle must have at least 1 tail light fitted on or towards the rear of the vehicle.
- (2) A motor trike with 2 rear wheels, or a motor vehicle with 4 or more wheels, built after 1959 must have at least 1 tail light fitted on or towards each side of the rear of the vehicle.
- (3) A trailer built after June 1973 must have at least 1 tail light fitted on or towards each side of the rear of the vehicle.
- (4) The centre of a tail light mentioned in subrule (1), (2) or (3) must not be over:
- (a) 1.5 metres above ground level; or
  - (b) if it is not practicable to fit the light lower—2.1 metres above ground level.
- (5) A vehicle may have 1 or more additional tail lights at any height above ground level.

### **87—Pattern of fitting tail lights**

- (1) If only 1 tail light is fitted to a vehicle, it must be fitted in the centre or to the right of the centre of the vehicle's rear.
- (2) Subrule (1) applies to a motor bike with an attached sidecar as if the sidecar were not attached.
- (3) If 2 or more tail lights are fitted to a vehicle, at least 2 must be fitted as a pair.

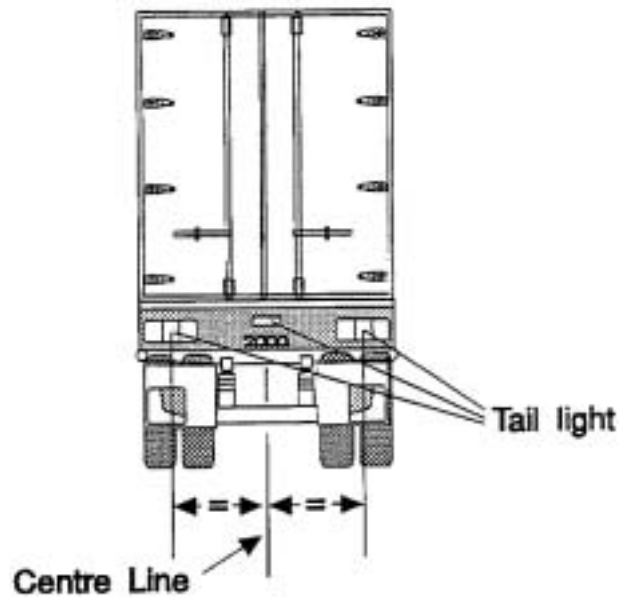

Location of tail lights on a vehicle

- (4) Tail lights fitted in accordance with this Division may also serve as rear clearance lights if they are fitted to a vehicle in accordance with rule 93 (3).

### 88—Performance of tail lights

- (1) When on, a tail light of a vehicle must:
- show a red light visible 200 metres from the rear of the vehicle; and
  - not use over 7 watts power.
- (2) A tail light fitted to a street rod vehicle may incorporate a blue lens not over 20 millimetres in diameter.
- (3) A street rod vehicle is a vehicle that has been modified for safe road use and that:
- has a body and frame that were built before 1949; or
  - is a replica of a vehicle the body and frame of which were built before 1949.

### 89—Wiring of tail lights

A tail light of a motor vehicle must be wired to come on, and stay on, when a parking light or headlight on the vehicle is on, unless an external switch is fitted to operate the tail light.

## Division 6—Number plate lights

### 90—Number plate lights

- (1) At least 1 number plate light must be fitted to the rear of a vehicle.
- (2) When on, the number plate light or lights must illuminate a number plate on the rear of the vehicle with white light, so the characters on the number plate can be read at night 20 metres from the rear of the vehicle.
- (3) A number plate light:
- may be combined with another light; and

- (b) must not project white light to the rear of the vehicle except by reflection; and
- (c) must not obscure the characters on the number plate; and
- (d) must be wired to come on, and stay on, when a parking light, headlight or tail light on the vehicle is on.

## **Division 7—Clearance lights**

### **91—Front clearance lights**

- (1) Front clearance lights may only be fitted to a vehicle that is at least 1.8 metres wide.
- (2) A pair of front clearance lights must be fitted to a motor vehicle that is at least 2.2 metres wide, or a prime mover.
- (3) The centre of a front clearance light must be:
  - (a) not over 400 millimetres from the nearer side of the vehicle; and
  - (b) if the vehicle was built after June 1953:
    - (i) at least 750 millimetres higher than the centre of any low-beam headlight fitted to the vehicle; or
    - (ii) not lower than the top of the windscreen.
- (4) However, a front clearance light may be mounted on an external rear vision mirror or a mirror support if, when the mirror is correctly adjusted, no part of the lens of the clearance light is visible to a person in the normal driving position.
- (5) When on, a front clearance light must:
  - (a) show a yellow or white light visible 200 metres from the front of the vehicle; and
  - (b) not use over 7 watts power.

### **92—External cabin lights**

- (1) A motor vehicle fitted with front clearance lights may also have additional forward-facing lights on or above the roof of its cabin.
- (2) The additional forward-facing lights must be spaced evenly between the front clearance lights, with their centres at least 120 millimetres apart.
- (3) When on, an additional forward-facing light must:
  - (a) show a yellow or white light; and
  - (b) not use over 7 watts power.

### **93—Rear clearance lights**

- (1) Rear clearance lights may only be fitted to a vehicle that is at least 1.8 metres wide.
- (2) A pair of rear clearance lights must be fitted to the rear of a vehicle that is at least 2.2 metres wide.
- (3) The centre of a rear clearance light must be:
  - (a) not over 400 millimetres from the nearer side of the vehicle; and

- (b) if practicable, at least 600 millimetres above ground level.
- (4) When on, a rear clearance light must:
  - (a) show a red light visible 200 metres from the rear of the vehicle; and
  - (b) not use over 7 watts power.

## **Division 8—Side marker lights**

### **94—Vehicles needing side marker lights**

- (1) A pair of side marker lights must be fitted towards the rear of the sides of a motor vehicle that is over 7.5 metres long and at least 2.2 metres wide.
- (2) A pole-type trailer, and a motor vehicle built to tow a pole-type trailer, with at least 1 cross-bar or bolster must have a side marker light fitted to each side of the back or only cross-bar or bolster.
- (3) A pole-type trailer with 2 or more cross-bars or bolsters may also have a side marker light fitted to each side of the front cross-bar or bolster.
- (4) At least 2 side marker lights must be fitted to each side of:
  - (a) a trailer, except a pole-type trailer, that is at least 2.2 metres wide and not over 7.5 metres long; and
  - (b) a semi-trailer that is not over 7.5 metres long.
- (5) At least 3 side marker lights must be fitted to each side of:
  - (a) a trailer, except a pole-type trailer, that is at least 2.2 metres wide and over 7.5 metres long; and
  - (b) a semi-trailer that is over 7.5 metres long.
- (6) For subrules (1), (4) and (5), the width of a vehicle is measured disregarding any anti-skid device mounted on wheels, central tyre inflation systems, lights, mirrors, reflectors, signalling devices and tyre pressure gauges.

### **95—Location of side marker lights**

- (1) The centre of a side marker light must not be over 150 millimetres from the nearer side of the vehicle.
- (2) A front side marker light fitted to a motor vehicle must be towards the front of the side of the vehicle with no part of the lens visible to the driver.
- (3) The centre of a front side marker light fitted to a trailer must be:
  - (a) within 300 millimetres of the front of the side of the trailer; or
  - (b) if the construction of the trailer makes it impracticable to comply with paragraph (a)—as near as practicable to the front of the trailer.
- (4) The centre of a rear side marker light fitted to a vehicle must be:
  - (a) within 300 millimetres of the rear of the side of the vehicle; or
  - (b) if the construction of the vehicle makes it impracticable to comply with paragraph (a)—as near as practicable to the rear of the vehicle.

- (5) Side marker lights fitted to a vehicle must, as far as practicable, be evenly spaced along the side of the vehicle.
- (6) Subrules (2) to (5) do not apply to side marker lights fitted to a cross-bar or bolster of a pole-type trailer.
- (7) Only the side marker lights nearest to the rear need be fitted if complying with subrules (3) and (4) would result in the front and rear side marker lights being under 2.5 metres apart.
- (8) A side marker light fitted to a vehicle must be fitted so:
  - (a) its centre is not over:
    - (i) 1.5 metres above ground level; or
    - (ii) if it is not practicable to fit it lower—2.1 metres above ground level; and
  - (b) its centre is at least 600 millimetres above ground level; and
  - (c) it is, as far as practicable, in a row of side marker lights along the side of the vehicle.
- (9) Subrule (8) (a) does not apply to a side marker light that is not required to be fitted to the vehicle by rule 94.

#### **96—Performance of side marker lights**

- (1) When on, a side marker light fitted to a vehicle must:
  - (a) show a light visible 200 metres from the vehicle; and
  - (b) not use over 7 watts power.
- (2) When on, a side marker light fitted to a vehicle must show:
  - (a) to the front of the vehicle—a yellow light; and
  - (b) to the rear of the vehicle:
    - (i) if the light also operates as a rear light or reflector—a red light; and
    - (ii) in any other case—a red or yellow light.
- (3) However, if a pole-type trailer with 2 or more cross-bars or bolsters has the side marker lights permitted by rule 94 (3):
  - (a) the side marker lights fitted to the front cross-bar or bolster may comply with subrule (2) (a) only; and
  - (b) the side marker lights fitted to the back cross-bar or bolster may comply with subrule (2) (b) only.

#### **97—Side marker lights and rear clearance lights**

The side marker light nearest to the rear of a vehicle may also be a rear clearance light for rule 93.



## Division 9—Brake lights

### 98—Fitting brake lights

- (1) A brake light must be fitted to the rear of a vehicle built after 1934.
- (2) A pair of brake lights must be fitted to the rear of:
  - (a) a motor vehicle built after 1959 that has 4 or more wheels; and
  - (b) a motor trike built after 1959 that has 2 rear wheels; and
  - (c) a trailer built after June 1973.
- (3) The centre of a brake light must be:
  - (a) at least 350 millimetres above ground level; and
  - (b) not over:
    - (i) 1.5 metres above ground level; or
    - (ii) if it is not practicable to fit the light lower—2.1 metres above ground level.
- (4) A vehicle may be fitted with 1 or more additional brake lights.
- (5) The centre of an additional brake light must be at least 350 millimetres above ground level.
- (6) If only 1 brake light is fitted to a vehicle, it must be fitted in the centre or to the right of the centre of the vehicle's rear.
- (7) Subrule (6) applies to a motor bike with an attached sidecar as if the sidecar were not attached.

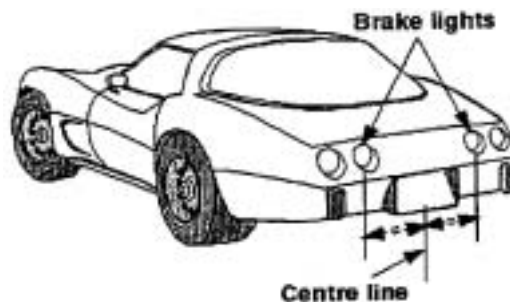

Location of brake lights on a vehicle

### 99—Performance and operation of brake lights

- (1) When on, a brake light must show a red light visible 30 metres from the rear of the vehicle.
- (2) A brake light fitted to a street rod vehicle may incorporate a blue lens not over 20 millimetres in diameter.
- (3) A brake light fitted to a motor vehicle must come on, if it is not already on, when:
  - (a) for a vehicle with 4 or more wheels or built after 1974—a service brake is applied; or
  - (b) for another vehicle—the rear wheel brake is applied.

- (4) Subrule (3) does not apply if the controls in the vehicle that start the engine are in a position that makes it impossible for the engine to operate.
- (5) A brake light on a trailer must come on when:
  - (a) the brake light of the towing vehicle comes on; or
  - (b) a brake control on the towing vehicle, which independently activates the service brake on the trailer, is operated.
- (6) A brake light may be operated by an engine brake, retarder, or similar device if the device does not interfere with the proper operation of the brake light.
- (7) A street rod vehicle is a vehicle that has been modified for safe road use and that:
  - (a) has a body and frame that were built before 1949; or
  - (b) is a replica of a vehicle the body and frame of which were built before 1949.

## **Division 10—Reversing lights**

### **100—Reversing lights**

- (1) One or more reversing lights may be fitted to the rear of a vehicle and on each side towards the rear of the vehicle.
- (2) A reversing light must have its centre not over 1.2 metres above ground level.
- (3) When on, a reversing light must show a white or yellow light to the rear or to the side and rear of the vehicle.

**Note—**

Third edition ADRs only allow white reversing lights.

- (4) A reversing light fitted to a motor vehicle must be wired so it operates only when the vehicle is reversing or in reverse gear.
- (5) A reversing light fitted to a trailer must be wired so it operates only when a motor vehicle towing the trailer is reversing or in reverse gear.
- (6) A yellow reversing light may also operate as a direction indicator light.

## **Division 11—Direction indicator lights**

### **101—Direction indicator lights on motor vehicles**

- (1) A motor vehicle with 4 or more wheels that was built after August 1966 must have:
  - (a) a pair of direction indicator lights fitted on, or towards, its front that face forwards; and
  - (b) a pair of direction indicator lights fitted on, or towards, its rear that face backwards.
- (2) A motor vehicle with less than 4 wheels that was built after June 1975 must have:
  - (a) a pair of direction indicator lights fitted on, or towards, its front that face forwards; and
  - (b) a pair of direction indicator lights fitted on, or towards, its rear that face backwards.

- (3) A motor vehicle that is not required to have direction indicator lights may have:
- (a) 1 or more pairs of direction indicator lights that are visible from both the front and rear of the vehicle; or
  - (b) both:
    - (i) a pair of direction indicator lights fitted on, or towards, its front that face forwards; and
    - (ii) a pair of direction indicator lights fitted on, or towards, its rear that face backwards.

### **102—Direction indicator lights on trailers**

- (1) A trailer built after June 1973 must have a pair of direction indicator lights fitted on, or towards, its rear that face backwards.
- (2) A trailer that is not required to have direction indicator lights may have 1 or more pairs of direction indicator lights fitted on, or towards, its rear that face backwards.

### **103—Location of direction indicator lights**

- (1) A pair of direction indicator lights fitted to a vehicle must have the centre of each light at least:
  - (a) for a motor bike or the single wheel end of a motor trike—300 millimetres from the centre of the other light; and
  - (b) for lights fitted at the 2 wheel end of a motor trike—600 millimetres from the centre of the other light, unless the centre of each direction indicator light is not over 400 millimetres from the nearer side of the vehicle; and
  - (c) for another vehicle with a width of not over 1300 millimetres—400 millimetres from the centre of the other light; and
  - (d) for another vehicle with a width of over 1300 millimetres—600 millimetres from the centre of the other light.
- (2) The centre of each direction indicator light must be at least 350 millimetres above ground level.
- (3) The centre of each light in a pair of direction indicator lights required to be fitted to a vehicle must not be over:
  - (a) 1.5 metres above ground level; or
  - (b) if it is not practicable for the light to be fitted lower—2.1 metres above ground level.
- (4) For subrule (1), the width of a vehicle is measured disregarding any anti-skid device mounted on wheels, central tyre inflation systems, lights, mirrors, reflectors, signalling devices and tyre pressure gauges.

### **104—Operation and visibility of direction indicator lights**

- (1) A direction indicator light fitted to a motor vehicle must:
  - (a) when operating, display regular flashes of light at a rate of not over 120, and:

- (i) for a motor vehicle with 4 or more wheels—at least 60, flashes a minute; and
    - (ii) for another motor vehicle—at least 45, flashes a minute; and
  - (b) be able to be operated by a person in the normal driving position; and
  - (c) be wired to an audible or visible device in the vehicle that tells the driver that the direction indicator light is operating; and
  - (d) flash at the same time and rate as any other direction indicator lights fitted on the same side of the vehicle.
- (2) A direction indicator light fitted to a side of a trailer must, when operating, flash at the same time and rate as the direction indicator light or lights fitted to the same side of the motor vehicle towing the trailer.
- (3) The flashes of light displayed by a direction indicator light must be:
- (a) if the light faces forwards—white or yellow; and
  - (b) if the light faces backwards:
    - (i) yellow; or
    - (ii) for a vehicle built before July 1973—yellow or red; and
  - (c) if the light faces out from the side of the vehicle:
    - (i) white or yellow towards the front and side; and
    - (ii) for a vehicle built before July 1973—yellow or red towards the rear and side; and
    - (iii) for a vehicle built after June 1973—yellow towards the rear and side.

**Note—**

The ADRs only allow yellow direction indicator lights.

- (4) If a motor vehicle's direction indicator lights display only yellow light, the vehicle may be equipped to allow the lights to operate simultaneously on both sides of the vehicle, if a visible or audible signal tells the driver when the lights are operating simultaneously.
- (5) When on, a direction indicator light must be visible 30 metres from:
- (a) if the light faces forwards—the front of the vehicle; or
  - (b) if the light faces backwards—the rear of the vehicle; or
  - (c) if the light faces out from the side of the vehicle—that side of the vehicle.
- (6) When on, each direction indicator light in at least 1 pair of lights fitted on or towards the front of a prime mover, or a motor vehicle over 7.5 metres long, must be visible at a point:
- (a) 1.5 metres at right angles from the side of the vehicle where the light is fitted; and
  - (b) in line with the rear of the vehicle.

## Division 12—Fog lights

### 105—Front fog lights

- (1) A pair of front fog lights may be fitted to a motor vehicle with 4 or more wheels.
- (2) A pair of front fog lights, or a single front fog light, may be fitted to a motor bike or trike.
- (3) A pair of front fog lights fitted to a motor vehicle with 4 or more wheels must have the centre of each light not over 400 millimetres from the nearer side of the vehicle unless the centres of the lights are at least 600 millimetres apart.
- (4) If the top of the front fog light is higher than the top of any low-beam headlight on the vehicle, the centre of the fog light must not be higher than the centre of the low-beam headlight.
- (5) A front fog light must:
  - (a) when on:
    - (i) project white or yellow light in front of the vehicle; and
    - (ii) be a low-beam light; and
  - (b) be able to be operated independently of any headlight; and
  - (c) be fitted so the light from it does not reflect off the vehicle into the driver's eyes.

### 106—Rear fog lights

- (1) A vehicle may have fitted to its rear:
  - (a) a pair of rear fog lights; or
  - (b) 1 rear fog light fitted on, or to the right, of the centre of the vehicle.
- (2) Subrule (1) (b) applies to a motor bike with an attached sidecar as if the sidecar were not attached.
- (3) A rear fog light must:
  - (a) have its centre:
    - (i) not over 1.5 metres above ground level; and
    - (ii) at least 100 millimetres from the centre of a brake light; and
  - (b) when on, project red light behind the vehicle; and
  - (c) not use over 27 watts power; and
  - (d) be wired to a visible device in the vehicle that tells the driver that the rear fog light is operating.

## Division 13—Interior lights

### 107—Interior lights

A vehicle may be fitted with interior lights that illuminate any interior part of the vehicle.

## **Division 14—Reflectors generally**

### **108—General requirements for reflectors**

- (1) A reflector fitted to a vehicle must show a red, yellow or white reflection of light when light is projected directly onto the reflector at night by a low-beam headlight that:
  - (a) is 45 metres from the reflector; and
  - (b) complies with the Vehicle Standards.
- (2) The reflection must be clearly visible from the position of the headlight.

## **Division 15—Rear reflectors**

### **109—Rear reflectors**

- (1) A motor vehicle with 4 or more wheels, and a trailer, must have a rear-facing red reflector towards each side of its rear.
- (2) A motor bike, a sidecar attached to a motor bike, and a motor trike, must have a rear-facing red reflector.
- (3) The centre of each reflector must be:
  - (a) at the same height above ground level; and
  - (b) not over 1.5 metres above ground level.
- (4) However, subrule (3) does not apply to a reflector fitted to a sidecar attached to a motor bike.
- (5) A reflector fitted to a motor vehicle with 4 or more wheels, or a trailer, must not be over 400 millimetres from the nearer side of the vehicle.
- (6) A vehicle fitted with rear-facing red reflectors in accordance with subrule (1) or (2) may be fitted with additional red reflectors at any height above ground level or at any distance from the side of the vehicle.

## **Division 16—Side reflectors**

### **110—Compulsory side reflectors on pole-type trailers**

- (1) Yellow or red side-facing reflectors must be fitted to the pole of a pole-type trailer so:
  - (a) 1 reflector is fitted to the middle third of the left and right faces of the pole; and
  - (b) the front reflector is not over 3 metres from the front of the trailer; and
  - (c) the other reflectors are not over 3 metres apart.
- (2) Additional side-facing reflectors may be fitted to a pole-type trailer in accordance with rule 111.

### **111—Optional side reflectors**

- (1) A vehicle may be fitted with side-facing reflectors.

- (2) A side-facing reflector:
  - (a) towards the front of the vehicle must be yellow or white; and
  - (b) towards the rear of the vehicle must be yellow or red; and
  - (c) on the central part of the vehicle must be yellow.

## **Division 17—Front reflectors**

### **112—Compulsory front reflectors on trailers**

- (1) A front-facing white or yellow reflector must be fitted towards each side of the front of:
  - (a) a semi-trailer, except a pole-type trailer; and
  - (b) the front cross-bar or bolster of a pole-type trailer; and
  - (c) a trailer that is at least 2.2 metres wide.
- (2) Each reflector must have its centre:
  - (a) at the same height above ground level; and
  - (b) not over 1.5 metres above ground level; and
  - (c) not over 400 millimetres from the nearer side of the vehicle.
- (3) Additional front-facing reflectors may be fitted to a trailer mentioned in subrule (1) in accordance with rule 113.

### **113—Optional front reflectors**

- (1) A motor vehicle with 4 or more wheels, or a trailer, may have 1 or more front-facing white or yellow reflectors fitted towards each side of its front.
- (2) A motor vehicle with less than 4 wheels may have 1 or more front-facing white or yellow reflectors.
- (3) The centre of at least 1 reflector on each side of the front of the vehicle must be:
  - (a) at the same height above ground level as the centre of the other reflector; and
  - (b) the same distance from the longitudinal axis of the vehicle as the centre of the other reflector; and
  - (c) at least:
    - (i) for a vehicle with a width under 1300 millimetres—400 millimetres from the centre of the other reflector; and
    - (ii) for another vehicle—600 millimetres from the centre of the other reflector.
- (4) For subrule (3) (c), the width of a vehicle is measured disregarding any anti-skid device mounted on wheels, central tyre inflation systems, lights, mirrors, reflectors, signalling devices and tyre pressure gauges.

## Division 18—Warning lights and signs on buses carrying children

### 114—Application of division

This division applies to a bus that is used mainly for carrying children if the bus is fitted with warning lights after June 1999.

**Note—**

For warning signs and lights fitted before July 1999, see rule 118.

### 115—Fitting of warning lights and signs

- (1) Two warning lights and a warning sign must be fitted to the front and rear of the bus.
- (2) The warning lights must be fitted:
  - (a) on each side of, and the same distance from, the centre of the warning sign; and
  - (b) with the edge of the warning sign not over 100 millimetres from the nearest point on the lens of the warning lights; and
  - (c) with the distance between the warning lights at least 300 millimetres at the nearest point; and
  - (d) so no part of the bus obstructs the light displayed:
    - (i) 30° to the left and right of the centre of each light; and
    - (ii) 10° above and below the centre of each light.
- (3) The warning lights may be on the warning sign if the words or image on the sign are not obscured.
- (4) The warning lights at the same end of the bus must be fitted:
  - (a) at the same height; and
  - (b) as high as practicable; and
  - (c) with the lowest point on the lens of each light not lower than midway between the highest and lowest points on the bus body.
- (5) If the centres of the warning lights are under 1.8 metres above ground level, no part of the warning lights or warning sign may be on the left of the bus.
- (6) This rule applies to a bus despite any requirement of a third edition ADR.

### 116—Operation and performance of warning lights

- (1) When operating, a warning light must display regular flashes of yellow light at a rate of at least 90, and not over 180, flashes a minute.
- (2) The warning lights at the same end of the bus must flash alternately.
- (3) Unless the driver has turned the warning lights off, they must operate automatically when a door on the bus opens and for at least 10, and not over 20, seconds after all the doors on the bus have closed.
- (4) The bus must have a visible or audible signal that tells the driver when the warning lights are operating.



- (5) The bus must be fitted with a switch that allows the driver to turn the warning lights off.
- (6) A warning light must have:
- (a) an effective lit lens area of at least 60 square centimetres; and
  - (b) a luminous intensity (in candela) of at least the values mentioned in the following table when measured at the angles mentioned in the table.

Vertical angle from centre of light	Horizontal angle from centre of light								
	-30°	-20°	-10°	-5°	0°	5°	10°	20°	30°
10°				50	80	50			
5°		180	320	350	450	350	320	180	
0°	75	450	1000	1250	1500	1250	1000	450	75
-5°	40	270	450	570	600	570	450	270	40
-10°				75	75	75			

- (7) For subrule (6) (b), the luminous intensity of a light is to be measured in accordance with the test method mentioned in third edition ADR 6.

### 117—Specifications for warning signs

- (1) A warning sign at the front of the bus must:
- (a) display the words "school bus" in capital letters at least 100 millimetres high; or
  - (b) display an image of 2 children in the same proportions as the children in AS 1743 Road Signs—Specifications (image W6-3), with the image of the taller child at least 230 millimetres high.
- (2) A warning sign at the rear of the bus must display an image of 2 children in the same proportions as the children in AS 1743 Road Signs—Specifications (image W6-3), with the image of the taller child at least 230 millimetres high.
- (3) The warning sign mentioned in subrules (1) (b) and (2) must:
- (a) be a rectangular shape at least:
    - (i) if warning lights are on the warning sign—550 millimetres wide and 400 millimetres high; and
    - (ii) in any other case—400 millimetres wide and 250 millimetres high; and
  - (b) have a black border; and
  - (c) have black graphics and be coated with yellow retro-reflective material of class 1 or 2 that meets Australian Standard AS 1906 Retro-reflective Materials and Devices for Road Traffic Control Purposes.

## Division 19—Other lights, reflectors, rear marking plates or signals

### 118—Other lights and reflectors

(1) In this rule:

*exempt vehicle* means:

- (a) a police vehicle; or
- (b) an emergency vehicle.

*special use vehicle* means:

- (a) a vehicle built, fitted or acquired for a special use that when so used may result in a hazardous situation on a road; or
- (b) a vehicle, or combination, that because of its dimensions is permitted to be driven on a road only in accordance with an oversize or overmass vehicle exemption (see section 115 of the *Road Traffic Act 1961*); or
- (c) a vehicle built or fitted to accompany a vehicle, or combination, mentioned in paragraph (b); or
- (d) a bus fitted, before July 1999, with a sign telling road users that the bus carries children.

**Examples of special use vehicles to which paragraph (a) applies—**

- 1 Tow trucks.
- 2 Vehicle breakdown service vehicles.
- 3 Weed spraying vehicles.
- 4 Power driven lawn mowers.
- 5 Animal rescue vehicles.
- 6 Vehicles used by primary producers droving stock between paddocks.
- 7 Buses fitted for use on the track commonly known as the O-Bahn busway.

(2) A vehicle may be fitted with any light or reflector not mentioned in the Vehicle Standards.

(3) However, unless subrule (4) applies, a vehicle must not display:

- (a) a light that flashes; or
- (b) a light or reflector that:
  - (i) shows a red light to the front; or
  - (ii) shows a white light to the rear; or
  - (iii) is shaped or located in a way that reduces the effectiveness of a light or reflector that is required to be fitted to the vehicle under the Vehicle Standards.

(4) Despite any requirement of a third edition ADR:

- (a) an exempt vehicle may be fitted with any light or reflector;
- (b) a special use vehicle may be fitted with 1 or more flashing yellow lights;

- (c) a State Government enforcement vehicle may be fitted with 1 or more flashing magenta lights.

### 119—Rear marking plates

- (1) In this rule:

*rear marking plates* means rear marking plates:

- (a) that comply with third edition ADR 45 and are fitted in accordance with rule 119A; or
- (b) that comply with, and are fitted in accordance with, Australian Standard AS 4001-1992 Motor Vehicle—Rear Marker Plates.
- (2) Rear marking plates must be fitted to:
- (a) a motor vehicle with a GVM over 12 tonnes, except a bus fitted with hand grips or similar equipment for standing passengers to hold; and
- (b) a trailer with a GTM over 10 tonnes.
- (3) Subrule (2) applies to a vehicle even if it was built before the date stated in third edition ADR 45.
- (4) Rear marking plates may be fitted to a motor vehicle with a GVM not over 12 tonnes or a trailer with a GTM not over 10 tonnes.

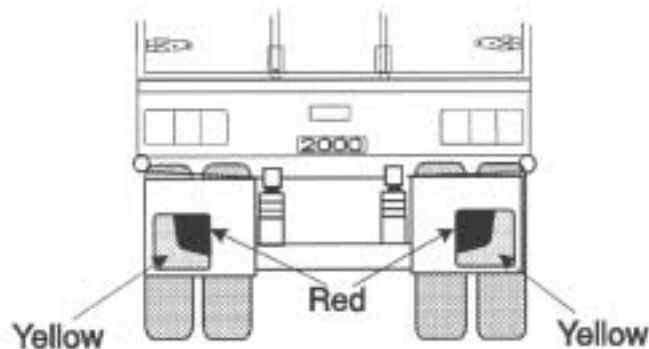

An example of rear marking plates



An alternative pattern for rear marking plates

#### 119A—Fitting of rear marking plates

- (1) In this rule, a reference to a rear marking plate of a specified category means a plate identified in third edition ADR 45 as a plate of that category.
- (2) For the purposes of paragraph (a) of the definition of *rear marking plates* in rule 119(1), rear marking plates must be fitted to a vehicle in the manner specified in this rule.

- (3) Rear marking plates must be fitted in accordance with one of the following arrangements:
- (a) 2 category 1 plates arranged in accordance with the diagram below ("Arrangement A"); or
  - (b) if it is not possible to fit 2 category 1 plates in accordance with Arrangement A:
    - (i) 1 category 2 plate arranged in accordance with the diagram below ("Arrangement B"); or
    - (ii) 1 category 2a plate and 1 category 2b plate arranged horizontally in accordance with the diagram below ("Arrangement C"); or
    - (iii) 1 category 2a plate and 1 category 2b plate arranged vertically in accordance with the diagram below ("Arrangement D").

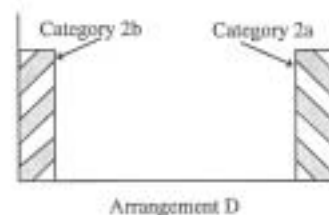
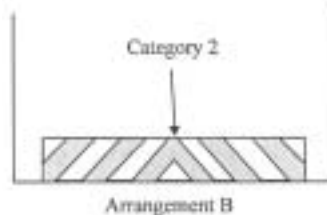
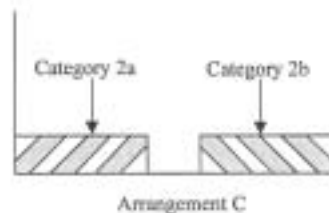
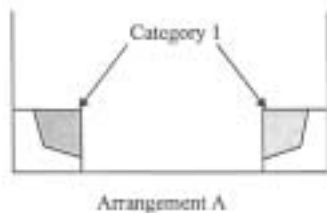

- (4) A rear marking plate must be fitted to the rear of the vehicle as follows:
- (a) a plate must face rearwards with its main face within  $20^\circ$  of a vertical plane that is at  $90^\circ$  to the vertical plane through the longitudinal axis of the vehicle;
  - (b) the outer edge of a plate:
    - (i) must be within 150 millimetres of the nearest extreme outer face of the vehicle or, if that is not practicable, as near as possible to (and no more than 500 millimetres from) the nearest extreme outer face; and
    - (ii) must not protrude beyond that nearest extreme outer face of the vehicle;
  - (c) the lower edge of a plate must be:
    - (i) horizontal; and
    - (ii) not less than 400 millimetres and not more than 1 500 millimetres (or, if that is not possible, 2 metres) above the ground,and if there is more than 1 plate, each plate must be at the same height;
  - (d) the whole of a plate must be visible:

- (i) in the horizontal plane—from any angle greater than an angle of 30° to the face of the plate; and
  - (ii) in the vertical plane—from any angle 15° or less above or below the horizontal,  
unless it is not possible to comply with subparagraphs (i) and (ii), in which case the whole of the plate must be visible from a point 100 metres from the rear of the vehicle and 1 500 millimetres above the ground.
- (5) Where rear marking plates are fitted to a vehicle that has a skeleton structure, the plates may be fitted:
  - (a) on fabricated supports (provided that the supports are well clear of any load carried by the vehicle); or
  - (b) to moveable panels that can be swung aside for loading; or
  - (c) in the case of a vehicle with tip-up loading ramps, to the undersides of the ramps.
- (6) Where, in order to comply with this rule, it is necessary to fit a rear marking plate across the edges of moveable or opening panels on a vehicle:
  - (a) the plate may be cut into two parts and fitted to adjacent panels (provided that any gap between the two parts does not exceed 25 millimetres); and
  - (b) part of the plate (not exceeding 10 millimetres in width) may be removed along the line of the cut in order to maintain the overall dimensions of the plate when fitted.
- (7) A rear marking plate must not have a light fitted within the boundaries of the plate.

## 120—Signalling devices

- (1) This rule applies to a motor vehicle if:
  - (a) the vehicle is not fitted with a brake light or direction indicator light mentioned in Division 9 or 11; and
  - (b) the construction of the vehicle would otherwise prevent the driver from hand signalling an intention:
    - (i) to turn or move the vehicle to the right; or
    - (ii) to stop or suddenly reduce the speed of the vehicle.
- (2) The vehicle must be fitted with a mechanical signalling device or a pair of turn signals.

## 121—Mechanical signalling devices

- (1) A mechanical signalling device must:
  - (a) be fitted to the right side of the vehicle; and
  - (b) be able to be operated by the driver from a normal driving position; and
  - (c) consist of a white or yellow representation of an open human hand at least 15 centimetres long; and
  - (d) be constructed so that the driver of the vehicle can keep the device:

- (i) in a neutral position so it is unlikely that the driver of another vehicle or anyone else would regard it as a signal; and
  - (ii) in a horizontal position with the palm of the hand facing forwards and the fingers pointing out at a right angle to the vehicle to signal an intention to turn or move right; and
  - (iii) with the palm of the hand facing forwards and the fingers pointing upwards to signal an intention to stop or reduce speed suddenly.
- (2) When the mechanical signalling device is in a position mentioned in subrule (1) (d) (ii) or (iii), the complete hand must be clearly visible from both the front and the rear of the vehicle, at a distance of 30 metres.

## **122—Turn signals**

A turn signal must:

- (a) consist of a steady or flashing illuminated yellow sign at least 15 centimetres long and 25 millimetres wide that:
  - (i) when in operation—is kept horizontal; and
  - (ii) when not in operation—is kept in a position so it is unlikely that the driver of another vehicle or anyone else would regard it as a signal; and
- (b) be fitted to the side of the motor vehicle at least 50 centimetres and not over 2.1 metres above ground level, in a position so the driver of the vehicle, from the normal driving position, can see whether the signal is in operation; and
- (c) be able to be operated by the driver from the normal driving position; and
- (d) when in operation, be visible from both the front and rear of the vehicle at a distance of 30 metres.

## **Division 20—Vehicles not required to have lights or reflectors**

### **123—Certain vehicles used in daylight**

This Part does not apply to a vehicle built before 1931 that is used only in the daylight.

### **124—Certain vehicles used for exhibition purposes**

This Part does not apply to a vehicle built before 1946 that is used mainly for exhibition purposes.

## **Part 9—Braking systems**

**Note—**

This Part sets out the braking system requirements for vehicles to ensure that they can be reliably slowed or stopped even if a part of a braking system fails, and to ensure that a vehicle can be prevented from rolling away when parked.

The Part also includes special requirements for braking systems on B-doubles and road trains to ensure that the braking systems on the component vehicles are compatible. The special requirements do not apply to a road train that is 19 metres long or less.

## Division 1—Brake requirements for all vehicles

### 125—Parts of a braking system

- (1) A brake tube or hose fitted to a vehicle must:
  - (a) be manufactured from a material appropriate to its intended use in the vehicle; and
  - (b) be long enough to allow for the full range of steering and suspension movements of the vehicle; and
  - (c) be fitted to prevent it being damaged during the operation of the vehicle by:
    - (i) a source of heat; or
    - (ii) any movement of the parts to which it is attached or near.
- (2) Each component of the braking system of a vehicle with a GVM over 4.5 tonnes must comply with the design and performance requirements of:
  - (a) a relevant Australian Standard or British Standard as in force when this subrule commenced; or
  - (b) a relevant standard approved by any of the following bodies, and as in force when this subrule commenced:
    - American Society of Automotive Engineers
    - American National Standards Institute
    - Japanese Standards Association
    - Deutsches Institut für Normung
    - International Organisation for Standardisation.

### 126—Provision for wear

The braking system of a vehicle must allow for adjustment to take account of normal wear.

### 127—Supply of air or vacuum to brakes

- (1) If air brakes are fitted to a vehicle:
  - (a) the compressor supplying air to the brakes must be able to build up air pressure to at least 80% of the governor cut-out pressure in not over 5 minutes after the compressed air reserve is fully used up; and
  - (b) for a vehicle with a GVM over 4.5 tonnes—the air storage tanks must have sufficient capacity to allow 5 applications of the service brakes before the air pressure drops below half the governor cut-out pressure; and
  - (c) there must be an automatic or manual condensate drain valve at the lowest point of each air brake reservoir in the system; and
  - (d) any spring brake fitted to the vehicle must not operate before the warning mentioned in rule 131 (4) (a) or 134 (3) (a) has been given.

- (2) If vacuum brakes are fitted to a vehicle, the vacuum supply must be able to build up vacuum:
- (a) to the level when the warning signal mentioned in rule 131 (4) (a) or 134 (3) (a) no longer operates within 30 seconds after the vacuum reserve is fully used up; and
  - (b) to the normal working level within 60 seconds after the vacuum reserve is fully used up.

### **128—Performance of braking systems**

- (1) One sustained application of the brake of a motor vehicle built after 1930, or a combination that includes a motor vehicle built after 1930, must be able to produce the performance mentioned in subrules (2) to (7):
- (a) when the vehicle or combination is on a dry, smooth, level road surface, free from loose material; and
  - (b) whether or not the vehicle or combination is loaded; and
  - (c) without part of the vehicle or combination moving outside a straight path:
    - (i) centred on the longitudinal axis of the vehicle or combination before the brake was applied; and
    - (ii) 3.7 metres wide.
- (2) The braking system of a motor vehicle or combination with a gross mass under 2.5 tonnes must bring the vehicle or combination from a speed of 35 kilometres an hour to a stop within:
- (a) 12.5 metres when the service brake is applied; and
  - (b) 30 metres when the emergency brake is applied.
- (3) The braking system of a motor vehicle or combination with a gross mass of at least 2.5 tonnes must bring the vehicle or combination from a speed of 35 kilometres an hour to a stop within:
- (a) 16.5 metres when the service brake is applied; and
  - (b) 40.5 metres when the emergency brake is applied.
- (4) The braking system of a motor vehicle or combination with a gross mass under 2.5 tonnes must decelerate the vehicle or combination, from any speed at which the vehicle or combination can travel, by an average of at least:
- (a) 3.8 metres a second a second when the service brake is applied; and
  - (b) 1.6 metres a second a second when the emergency brake is applied.
- (5) The braking system of a motor vehicle or combination with a gross mass of at least 2.5 tonnes must decelerate the vehicle or combination, from any speed at which the vehicle or combination can travel, by an average of at least:
- (a) 2.8 metres a second a second when the service brake is applied; and
  - (b) 1.1 metres a second a second when the emergency brake is applied.



- (6) The braking system of a motor vehicle or combination with a gross mass under 2.5 tonnes must achieve a peak deceleration of the vehicle or combination, from any speed at which the vehicle or combination can travel, of at least:
  - (a) 5.8 metres a second a second when the service brake is applied; and
  - (b) 1.9 metres a second a second when the emergency brake is applied.
- (7) The braking system of a motor vehicle or combination with a gross mass of at least 2.5 tonnes must achieve a peak deceleration of the vehicle or combination, from any speed at which the vehicle or combination can travel, of at least:
  - (a) 4.4 metres a second a second when the service brake is applied; and
  - (b) 1.5 metres a second a second when the emergency brake is applied.
- (8) The parking brake of a vehicle or combination must be able to hold the vehicle or combination stationary on a 12% gradient.

## Division 2—Motor vehicle braking systems

### 129—Motor vehicle braking system requirements

- (1) In this rule:

*independent brake*, for a vehicle, means a brake that is operated entirely separately from any other brake on the vehicle, except for any drum, disc or part, on which a shoe, band or friction pad makes contact, that is common to 2 or more brakes.
- (2) A motor vehicle with 4 or more wheels built, or used, mainly for transporting goods or people by road must be fitted with:
  - (a) a braking system that:
    - (i) consists of brakes fitted to all wheels of the vehicle; and
    - (ii) has at least 2 separate methods of activation, arranged so effective braking remains on at least 2 wheels if a method fails; or
  - (b) 2 independent brakes, each of which, when in operation, acts directly on at least half the number of wheels of the vehicle.
- (3) The braking system of a motor vehicle mentioned in subrule (2) that was built after 1945 must have a service brake operating on all wheels that, when applied:
  - (a) acts directly on the wheels and not through the vehicle's transmission; or
  - (b) acts on a shaft between a differential of the vehicle and a wheel.
- (4) The braking system of a motor vehicle with 4 or more wheels must have a parking brake that:
  - (a) is held in the applied position by direct mechanical action without the intervention of an electrical, hydraulic or pneumatic device; and
  - (b) is fitted with a locking device that can hold the brake in the applied position; and
  - (c) has its own separate control.
- (5) The parking brake may also be the emergency brake.

- (6) If 2 or more independent brakes are fitted to a motor vehicle with 4 or more wheels, the brakes must be arranged so brakes are applied to all the wheels on at least 1 axle of the vehicle when any brake is operated.
- (7) A motor bike or motor trike must be fitted with:
  - (a) 2 independent brakes; or
  - (b) a single brake that acts directly on all wheels of the vehicle and is arranged so effective braking remains on at least 1 wheel if a part of the system fails.
- (8) Subrule (7) applies to a motor bike with a sidecar attached as if the sidecar were not attached.
- (9) A motor trike must have a parking brake that is held in the applied position by mechanical means.

### **130—Operation of brakes on motor vehicles**

The braking system on a motor vehicle must be arranged to allow the driver of the motor vehicle to apply the brakes from a normal driving position.

### **131—Air or vacuum brakes on motor vehicles**

- (1) If a motor vehicle has air brakes, the braking system of the vehicle must include at least 1 air storage tank.
- (2) If a motor vehicle has vacuum brakes, the braking system of the vehicle must include at least 1 vacuum storage tank.
- (3) An air or vacuum storage tank must be built so the service brake can be applied to meet the performance standards of rule 128 at least twice if the engine of the vehicle stops or the source of air or vacuum fails.
- (4) An air or vacuum storage system must:
  - (a) be built to give a visible or audible warning to the driver, while in a normal driving position, of a lack of air or vacuum that would prevent the service brake from being applied to meet the performance standards of rule 128 at least twice; and
  - (b) be safeguarded by a check valve or other device against loss of air or vacuum if the supply fails or leaks.
- (5) However, subrule (4) (a) does not apply to a vehicle with a GVM of 4.5 tonnes or less that is fitted with an air or vacuum assisted braking system.
- (6) If air or vacuum brakes are fitted to a motor vehicle equipped to tow a trailer, the brakes of the motor vehicle must be able to stop the motor vehicle, at the performance standards for emergency brakes under rule 128 if the trailer breaks away.
- (7) The braking system of a motor vehicle with a GVM over 4.5 tonnes equipped to tow a trailer fitted with air brakes must include protection against loss of supply line air or brake control signal air.
- (8) The protection mentioned in subrule (7) must:
  - (a) operate automatically if a brake supply line hose connecting the motor vehicle and a trailer fails; and

- (b) maintain enough air pressure to allow the brakes to be applied to meet performance standards for emergency brakes under rule 128; and
- (c) include a visible or audible warning to the driver.

### **Division 3—Trailer braking systems**

#### **132—Trailer braking requirements**

- (1) A trailer with a GTM over 750 kilograms must have brakes that operate on at least 1 wheel at each end of 1 or more axles of the trailer.
- (2) A semi-trailer or converter dolly with a GTM over 2 tonnes must have brakes that operate on all its wheels.

#### **133—Operation of brakes on trailers**

- (1) The braking system of a trailer with a GTM over 2 tonnes must allow the driver of a motor vehicle towing the trailer to operate the brakes from a normal driving position.
- (2) However, subrule (1) does not apply to an unloaded converter dolly that weighs under 3 tonnes if the motor vehicle towing the converter dolly has a GVM over 12 tonnes.
- (3) The brakes on a trailer with a GTM over 2 tonnes must:
  - (a) operate automatically and quickly if the trailer breaks away from the towing vehicle; and
  - (b) remain in operation for at least 15 minutes after a break-away; and
  - (c) be able to hold the trailer on a 12% grade while in operation after a break-away.

#### **134—Air or vacuum brakes on trailers**

- (1) If a trailer has air brakes, its braking system must include at least 1 air storage tank.
- (2) If a trailer has vacuum brakes, its braking system must include at least 1 vacuum storage tank.
- (3) An air or vacuum storage system must:
  - (a) be built to give a visible or audible warning to the driver of the towing vehicle, while in a normal driving position, of a lack of air or vacuum that would prevent the brakes from meeting the performance standards of rule 128; and
  - (b) be safeguarded by a check valve or other device against loss of air or vacuum if the supply fails or leaks.
- (4) Subrules (1), (2) and (3) do not apply to a trailer with a GTM of 2 tonnes or less.

### **Division 4—Additional brake requirements for B-double and long road trains**

#### **135—Application of Division to certain road trains**

This Division does not apply to a road train, or a vehicle used in a road train, if the road train has a length of 19 metres or less.

### **136—Braking system design for a prime mover in a B-double**

- (1) A prime mover used in a B-double must comply with second edition ADR 35A or third edition ADR 35.
- (2) A prime mover used in a B-double must also have an anti-lock braking system complying with third edition ADR 64, if the prime mover:
  - (a) was built after 1989; or
  - (b) was first used in a B-double after 1993; or
  - (c) is used in a B-double that includes a road tank vehicle carrying dangerous goods.

### **137—Braking system design for motor vehicles in road trains**

The performance of the service, secondary and parking brake systems of a motor vehicle used in a road train must comply with second edition ADR 35A or third edition ADR 35 if the vehicle would not otherwise be required to comply with an ADR about braking.

### **138—Braking system design for trailers in B-doubles or road trains**

- (1) The performance of the service, secondary and parking brake systems of a trailer (including a converter dolly) used in a B-double or road train must comply with second edition ADR 38 or third edition ADR 38 if the trailer would not otherwise be required to comply with an ADR about braking.
- (2) A road train trailer to which subrule (1) applies need not be fitted with a mechanical parking brake if it carries wheel chocks that provide a performance equal to the performance standard required for a parking brake system.
- (3) A semi-trailer, regardless of when it was built, must have an anti-lock braking system that complies with third edition ADR 38/01, if:
  - (a) it is being used in a B-double that includes a road tank vehicle, whether or not the semi-trailer is itself a road tank vehicle; and
  - (b) the road tank vehicle is carrying dangerous goods.

### **139—Air brakes of motor vehicles in B-doubles or road trains**

- (1) If a B-double or road train is fitted with brakes that operate using compressed air, the braking system of the motor vehicle must comply with subrules (2) and (3) when:
  - (a) the pressure is measured in an 800 millilitre vessel connected by a 2 metre pipe with a bore of approximately 13 millimetres to the coupling head of the braking system; and
  - (b) the air pressure before the brakes are applied is not under:
    - (i) the average of the maximum and minimum pressures in the operating pressure range specified by the vehicle's manufacturer; or
    - (ii) if there is no manufacturer's specification—650 kilopascals.
- (2) The pressure must reach at least 420 kilopascals within 400 milliseconds after the rapid and complete application of the foot-operated brake control.

- (3) After the brakes have been fully applied, the pressure must fall, within half a second after the release of the foot-operated brake control, to 35 kilopascals.

#### **140—Air brakes in a B-double or road train: least favoured chamber**

- (1) In this rule:  
*least favoured chamber* means the brake chamber with the longest line to the treadle valve in the prime mover.
- (2) The pressure in the least favoured chamber of the braking system of a B-double or road train with brakes that operate using compressed air must comply with subrules (3) and (4) when the air pressure before the brakes are applied is not under:
- (a) the average of the maximum and minimum pressures in the operating pressure range specified by the vehicle's manufacturer; or
  - (b) if there is no manufacturer's specification—650 kilopascals.
- (3) The pressure must reach at least 420 kilopascals within:
- (a) for a B-double—1 second after the rapid and complete application of the foot-operated brake control; or
  - (b) for a road train—1.5 seconds after the rapid and complete application of the foot-operated brake control.
- (4) After the brakes have been fully applied, the pressure must fall to 35 kilopascals, or the pressure at which the friction surfaces cease to contact each other, within:
- (a) for a B-double—1 second after the release of the foot-operated brake control; or
  - (b) for a road train—1.5 seconds after the release of the foot-operated brake control.

#### **141—Recovery of air pressure for brakes in B-doubles and road trains**

The air pressure in each air brake reservoir in a B-double or road train must recover to at least 420 kilopascals within 1 minute after 3 full brake applications have been made within a 10 second period if, before the 3 brake applications have been made:

- (a) the engine is running at maximum speed; and
- (b) the governor cut-in pressure is no higher than:
  - (i) the pressure specified by the vehicle's manufacturer; or
  - (ii) if there is no manufacturer's specification—550 kilopascals; and
- (c) the air pressure in the storage tanks of the vehicle is not under:
  - (i) the average of the maximum and minimum pressures in the operating pressure range specified by the vehicle's manufacturer; or
  - (ii) if there is no manufacturer's specification—650 kilopascals.

#### **142—Air supply for brakes in B-doubles and road trains**

A B-double or road train that uses compressed air to operate accessories must have:

- (a) sufficient air compressor capacity and air receiver volume to ensure that the operation of the accessories does not adversely affect brake performance; and

- (b) a compressed air system built to ensure that the brake system is preferentially charged.

### **143—Brake line couplings**

- (1) Brake line couplings on the same part of a vehicle in a B-double or road train must not be interchangeable.
- (2) The couplings must be polarised in accordance with Australian Standard AS D8–1971 Hose Couplings for Use with Vacuum and Air-Pressure Braking Systems on Prime Movers, Trailers and Semi-trailers if the hoses used with the brake couplings are used for the same purpose as the hoses mentioned in the standard.

### **144—Simultaneous parking brake application**

- (1) If the parking brake of a motor vehicle in a B-double or road train is applied, the parking brakes of any attached trailer must be applied automatically.
- (2) This rule does not apply to a trailer carrying wheel chocks complying with rule 138 (2).

### **145—Capacity of air reservoirs**

- (1) The capacity of the air storage tanks of a motor vehicle used in a B-double or road train must be at least 12 times the volume of all the brake activation chambers on the motor vehicle.
- (2) The capacity of the air storage tanks of a trailer used in a B-double or road train must be at least 8 times the volume of all the brake activation chambers on the trailer.

## **Part 10—Control of emissions**

### **Note—**

This Part sets out requirements to ensure that motor vehicles do not emit too much smoke or noise and that exhaust gases cannot enter the passenger compartment of a vehicle.

## **Division 1—Crank case gases and visible emissions**

### **146—Crank case gases**

- (1) This rule applies to a motor vehicle with 4 or more wheels that is powered by a petrol engine and was built after 1971.
- (2) The vehicle must be built to prevent, or fitted with equipment that prevents, crank case gases from escaping to the atmosphere.

### **147—Visible emissions**

- (1) This rule applies to a motor vehicle that is propelled by an internal combustion engine and was built after 1930.
- (2) The vehicle must not emit visible emissions for a continuous period of at least 10 seconds.
- (3) However, this rule does not apply to emissions that are visible only because of heat or the condensation of water vapour.

## Division 2—Exhaust systems

### 148—Exhaust systems

- (1) The outlet of the exhaust system fitted to a motor vehicle with a GVM over 4.5 tonnes (except a bus) must extend:
  - (a) behind the back seat; and
  - (b) at least 40 millimetres beyond the outermost joint of the floorpan that is not continuously welded or permanently sealed; and
  - (c) to the edge of the vehicle, if:
    - (i) the body of the vehicle is permanently enclosed; and
    - (ii) the vehicle is not fitted with a vertical exhaust system; and
  - (d) no further than the edge of the vehicle at its widest point.
- (2) The outlet must discharge the main exhaust flow to the air:
  - (a) if the vehicle is fitted, or required under a law of this jurisdiction to be fitted, with an exhaust system with a vertical outlet pipe:
    - (i) at an angle above the horizontal; and
    - (ii) at least 150 millimetres above the cab of the vehicle; and
    - (iii) rearwards or to the right of the vehicle; and
  - (b) in any other case:
    - (i) horizontally or at an angle of not over 45° downwards; and
    - (ii) under 750 millimetres above ground level; and
    - (iii) rearwards or to the right of the vehicle.
- (3) An exposed section of a vertical exhaust system fitted to a motor vehicle (except a bus) with a GVM over 4.5 tonnes must be positioned or shielded to prevent injury.
- (4) The outlet of the exhaust system fitted to a bus with a GVM over 4.5 tonnes must:
  - (a) be as near as practicable to the rear of the vehicle; and
  - (b) extend no further than the edge of the bus at its widest point.
- (5) The outlet must discharge the main exhaust flow to the air:
  - (a) if the bus is fitted, or required under a law of this jurisdiction to be fitted, with an exhaust system with a vertical outlet pipe:
    - (i) behind the passenger compartment; and
    - (ii) at an angle above the horizontal; and
    - (iii) upwards or rearwards; and
  - (b) in any other case:
    - (i) horizontally or at an angle of not over 45° downwards; and
    - (ii) rearwards or to the right of the vehicle.

- (6) A vertical exhaust system fitted to a motor vehicle with a GVM over 4.5 tonnes must:
- (a) if the vehicle is fitted with an exhaust system with a vertical outlet pipe that does not direct the main exhaust flow straight up—direct the flow rearwards at an angle within  $0^\circ$  to  $45^\circ$  of the longitudinal centre line of the vehicle; and
  - (b) if a rain cap is fitted to the outlet pipe—be installed so the hinge of the cap is at an angle of  $90^\circ$  (plus or minus  $10^\circ$ ) to the longitudinal centre line of the vehicle when viewed from above.

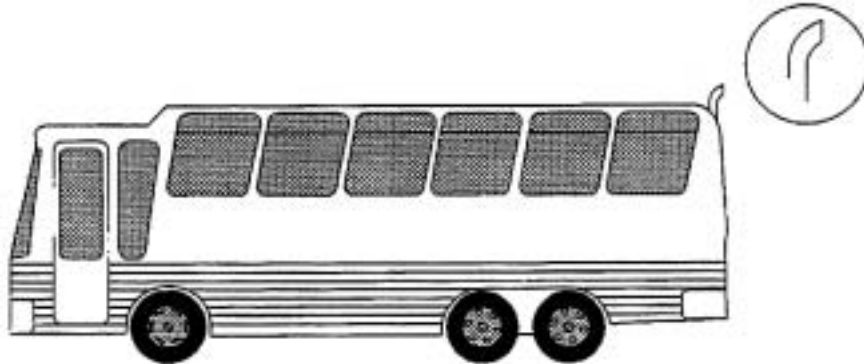

Bus exhaust outlet pipe

### **Division 3—Noise emissions**

#### **149—Silencing device for exhaust systems**

A motor vehicle propelled by an internal combustion engine must be fitted with a silencing device through which all the exhaust from the engine passes.

#### **150—Stationary noise levels—car-type vehicles and motor bikes and motor trikes**

- (1) In this rule:
- car-type vehicle*** means:
- (a) a car; or
  - (b) a utility truck, panel van, or another motor vehicle derived from a car design; or
  - (c) another motor vehicle with 4 or more wheels that is built mainly to carry not over 9 people including the driver.
- (2) The stationary noise level of a car-type vehicle, or motor bike or trike, must not exceed:
- (a) for a car-type vehicle built after 1982—90 dB(A); or
  - (b) for another car-type vehicle—96 dB(A); or
  - (c) for a motor bike or trike built after February 1985—94 dB(A); or
  - (d) for another motor bike or trike—100 dB(A).



**151—Stationary noise levels—other vehicles with spark ignition engines**

- (1) This rule applies to a motor vehicle (except a motor vehicle to which rule 150 applies) with a spark ignition engine.
- (2) The stationary noise level of the motor vehicle must not exceed the noise level applying to the vehicle under the table.

Column 1 Item	Column 2 GVM(t)	Column 3 Exhaust height (mm)	Column 4 When vehicle built	Column 5 Noise level (dB(A))
1	≤3.5	<1500	before July 1983	92
			after June 1983	89
2	>3.5	<1500	before July 1983	98
			after June 1983	95
3	≤3.5	≥1500	before July 1983	88
			after June 1983	85
4	>3.5	≥1500	before July 1983	94
			after June 1983	91

**152—Stationary noise levels—other vehicles with diesel engines**

- (1) This rule applies to a motor vehicle (except a motor vehicle to which rule 150 applies) with a diesel engine.
- (2) The stationary noise level of the motor vehicle must not exceed the noise level applying to the vehicle under the table.

Column 1 Item	Column 2 GVM (t)	Column 3 Exhaust height (mm)	Column 4 When vehicle built	Column 5 Noise level (dB(A))
1	≤3.5	<1500	before July 1980	105
			after June 1980 but before July 1983	102
			after June 1983	99
2	>3.5 but ≤12	<1500	before July 1980	107
			after June 1980 but before July 1983	104
			after June 1983	101
3	>12	<1500	before July 1980	109
			after June 1980 but before July 1983	106
			after June 1983	103
4	≤3.5	≥1500	before July 1980	101
			after June 1980 but before July 1983	98
			after June 1983	95

Column 1 Item	Column 2 GVM (t)	Column 3 Exhaust height (mm)	Column 4 When vehicle built	Column 5 Noise level (dB(A))
5	>3.5 but ≤12	≥1500	before July 1980	103
			after June 1980 but before July 1983	100
			after June 1983	97
6	>12	≥1500	before July 1980	105
			after June 1980 but before July 1983	102
			after June 1983	99

### 153—Measurement of stationary noise levels

For this Division, the stationary noise level of a motor vehicle is to be measured in accordance with the test method from time to time approved by the Minister by notice published in the Gazette.

## Part 11—Alternative fuel systems for vehicle engines

### Note—

This Part sets out requirements to ensure that alternative fuel systems are safely installed in motor vehicles.

Australian Design Rules for exhaust and evaporative emissions requirements are applicable to certain classes of vehicles fitted with LPG or CNG fuel systems.

### 154—Gaseous fuel powered vehicles

- (1) In this rule:
  - CNG** means compressed natural gas;
  - LPG** means liquefied petroleum gas.
- (2) A motor vehicle equipped to run on LPG must comply with the requirements for the use of LPG in vehicles in:
  - (a) Australian/New Zealand Standard AS/NZS 1425 as in force from time to time; or
  - (b) if an earlier version of the standard was current when the vehicle was first equipped to run on LPG—that version.
- (3) If a motor vehicle equipped to run on LPG is not required under subrule (2) to have a label affixed to the front and rear number plates of the vehicle, the vehicle must have fixed conspicuously to the front and rear number plates a label that is:
  - (a) made of durable material; and
  - (b) at least 25 millimetres wide and 25 millimetres high; and
  - (c) reflective red conforming to Australian Standard AS 1742-1975 Manual of Uniform Traffic Control Devices, Appendix C, Class 2; and

- (d) marked "LPGAS" or "LPG", or with words or acronyms to similar effect, in capital letters at least 6 millimetres high.
- (4) A motor vehicle equipped to run on CNG must comply with the requirements for the use of CNG in vehicles in:
  - (a) Australian/New Zealand Standard AS/NZS 2739 as in force from time to time; or
  - (b) if an earlier version of the standard was current when the vehicle was first equipped to run on CNG—that version.
- (5) For the purposes of this rule:
  - (a) a version of Australian Standard AS 1425 will be taken to be an earlier version of Australian/New Zealand Standard AS/NZS 1425; and
  - (b) a version of Australian Standard AS 2739 will be taken to be an earlier version of Australian/New Zealand Standard AS/NZS 2739.

## **Part 12—Maximum road speed limiting**

### **Note—**

This Part requires certain heavy vehicles built after 1987, but before July 1991, to have a restricted top speed. However, emergency vehicles and certain 2-axle prime movers owned by farmers and used in primary production are exempt.

### **155—Speed limiting**

- (1) A bus with a GVM over 14.5 tonnes that was built after 1987 must comply with third edition ADR 65.
- (2) A prime mover with a GVM over 15 tonnes that was built after 1987 must comply with third edition ADR 65.
- (3) For third edition ADR 65, the maximum road speed capability of a motor vehicle used in a road train is the speed from time to time fixed by the Minister by notice published in the Gazette.

### **156—Exemptions from speed limiting**

Rule 155 does not apply to:

- (a) an emergency vehicle or police vehicle; or
- (b) a bus fitted with hand grips or similar equipment for standing passengers to hold; or
- (c) a 2-axle prime mover if:
  - (i) it was built after 1987 but before July 1991; and
  - (ii) its owner is a person who uses it for agriculture, horticulture, or other primary production activities (except forestry, fishing and mining).

## **Part 13—Mechanical connections between vehicles**

### **Note—**

This Part sets out various requirements to ensure that the couplings used when operating motor vehicles and trailers in combinations are strong enough to hold them together.

The requirements in this Part about the mechanical connections between vehicles in a road train do not apply to a road train 19 metres long or less.

## **Division 1—Couplings on all types of vehicles**

### **157—General coupling requirements**

- (1) A fifth wheel coupling, the mating parts of a coupling, a kingpin or a towbar must not be used for a load more than the manufacturer's load rating.
- (2) A kingpin must be used only with a fifth wheel coupling that has a corresponding jaw size.

#### **Example—**

An adaptor must not be used to fit a kingpin to a fifth wheel coupling.

- (3) The mating parts of a coupling used to connect a semi-trailer to a towing vehicle must not allow the semi-trailer to roll to an extent that makes the towing vehicle unstable.

### **158—Drawbar couplings**

- (1) A coupling for attaching a trailer, except a semi-trailer or pole-type trailer, to a towing vehicle must be built and fitted so:
  - (a) the coupling is equipped with a positive locking mechanism; and
  - (b) the positive locking mechanism can be released regardless of the angle of the trailer to the towing vehicle.
- (2) If the trailer is in a combination and is not fitted with breakaway brakes in accordance with rule 133 (3), it must be connected to the towing vehicle by at least 1 chain, cable or other flexible device, as well as the coupling required by subrule (1).
- (3) The connection must be built and fitted so:
  - (a) the trailer is kept in tow if the coupling breaks or accidentally detaches; and
  - (b) normal angular movement of the coupling is permitted without unnecessary slack.
- (4) If practicable, the connection must be built and fitted so the drawbar of the trailer is prevented from hitting the ground if the coupling accidentally detaches.

## **Division 2—Additional coupling requirements for B-doubles and long road trains**

### **159—Application of Division to road trains**

This Division does not apply to a vehicle, coupling, or part of a coupling, used in a road train not over 19 metres long.

### **160—Couplings for B-doubles and road trains**

- (1) A fifth wheel coupling used to connect a towing vehicle to a semi-trailer used in a B-double or road train must not be built with a pivot that allows a semi-trailer to roll relative to the towing vehicle.
- (2) However, subrule (1) does not apply to a fifth wheel coupling if:
  - (a) the semi-trailer design requires torsional stresses to be minimised; and
  - (b) the roll axis of the fifth wheel coupling is above the surface of the coupler plate; and
  - (c) the degree of rotation allowed around the roll axis of the fifth wheel coupling is restricted to prevent roll instability.
- (3) A trailer with only 1 axle group, or a single axle, (except a semi-trailer or a converter dolly) that is used in a road train must not have a coupling fitted at its rear.

### **161—Selection of fifth wheel couplings for B-doubles and road trains**

- (1) A fifth wheel coupling used in a B-double or road train must have a D-value complying with Australian Standard AS 1773–1990 Articulated Vehicles—Fifth Wheel Assemblies.
- (2) A turntable used in a B-double or road train must have a D-value complying with Australian Standard AS 1773–1990 Articulated Vehicles—Fifth Wheel Assemblies.
- (3) If a fifth wheel coupling used in a B-double or road train is built for a 50 millimetre or 90 millimetre kingpin, the coupling must:
  - (a) meet the dimension requirements in Australian Standard AS 1773–1990 Articulated Vehicles—Fifth Wheel Assemblies; and
  - (b) not be worn away more than recommended by the standard.
- (4) If a fifth wheel coupling used in a B-double or road train is built for a 75 millimetre kingpin, the coupling must:
  - (a) be compatible with the kingpin mentioned in rule 165 (3); and
  - (b) not be worn away so that it does not comply with rule 162.

### **162—D-value of a fifth wheel coupling**

In testing a fifth wheel coupling built for a 75 millimetre kingpin used in a B-double or road train to decide whether its D-value complies with rule 161 (1), the longitudinal movement (after readjusting the jaws of the coupling using a kingpin built to the dimensions mentioned in rule 165 (3) (a)) must not be over 4 millimetres.

### **163—Mounting of fifth wheel couplings on B-doubles and road trains**

A fifth wheel coupling must be mounted on a prime mover, or a semi-trailer used in a B-double or road train, in accordance with Australian Standard AS 1771–1987 Installation of Fifth Wheel and Turntable Assemblies.

### **164—Branding of fifth wheel couplings and turntables on B-doubles and road trains**

- (1) A fifth wheel coupling on a vehicle built after June 1991 forming part of a B-double or road train must be clearly and permanently marked in accordance with Australian Standard AS 1773—1990 Articulated Vehicles—Fifth Wheel Assemblies with:
  - (a) the name or trademark of its manufacturer; and
  - (b) its D-value rating; and
  - (c) its nominal size.
- (2) A turntable used in a vehicle built after the commencement of this rule that forms part of a B-double or road train must be marked with:
  - (a) the name or trademark of the turntable's manufacturer; and
  - (b) the D-value rating of the turntable in accordance with Australian Standard AS 1773—1990 Articulated Vehicles—Fifth Wheel Assemblies.

### **165—Selection of kingpins for B-doubles and road trains**

- (1) A kingpin used in a B-double or road train must:
  - (a) be a 50, 75 or 90 millimetre kingpin; and
  - (b) have a D-value complying with Australian Standard AS 2175—1990 Articulated Vehicles—Kingpins.
- (2) A 50 or 90 millimetre kingpin used in a B-double or road train must:
  - (a) be built to meet the dimension requirements in Australian Standard AS 2175—1990 Articulated Vehicles—Kingpins; and
  - (b) not be worn away more than recommended by the standard.
- (3) A 75 millimetre kingpin used in a B-double or road train must:
  - (a) be built to meet the dimensions in the following essential diagram; and
  - (b) not be worn away more than mentioned in subrule (4).

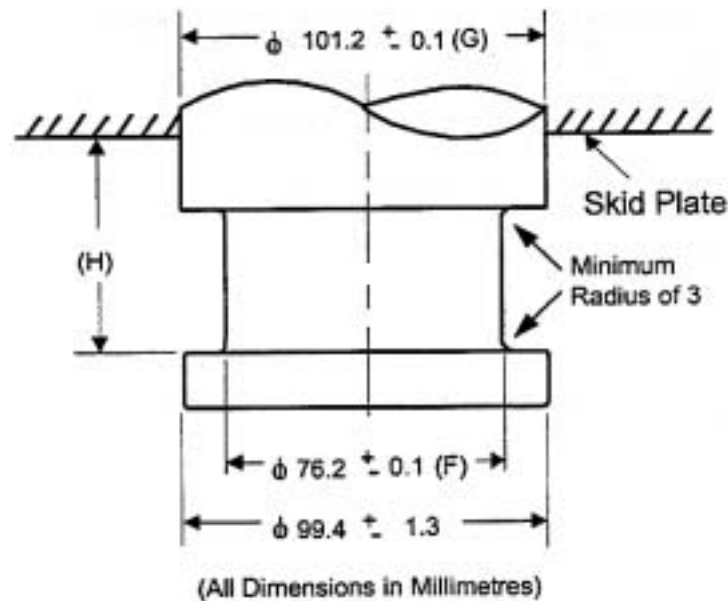

Dimensions of a 75 millimetre kingpin

- (4) In testing a 75 millimetre kingpin mentioned in the essential diagram in subrule (3) to decide whether its D-value complies with subrule (1) (b):
- diameter F must not wear more than 3 millimetres; and
  - diameter G must not wear more than 2 millimetres; and
  - height H must not wear more than 2.3 millimetres.

#### 166—Attachment of kingpins on B-doubles and road trains

A kingpin used in a trailer that forms part of a B-double or road train must be attached in accordance with:

- the manufacturer's specifications and instructions; or
- the guidelines detailed in Australian Standard AS 2175–1990 Articulated Vehicles—Kingpins.

#### 167—Branding of kingpins on B-doubles and road trains

A kingpin used in a trailer built after June 1991 that forms part of a B-double or road train must be clearly and permanently marked on the lower circular face of the kingpin in accordance with Australian Standard AS 2175–1990 Articulated Vehicles—Kingpins with:

- the name or trademark of its manufacturer; and
- its D-value rating; and
- its nominal size.

#### 168—Selection of couplings and drawbar eyes for roadtrains

A drawbar-type coupling, or drawbar eye, used in a road train must:

- be a 50 millimetre pin type; and

- (b) have a D-value complying with Australian Standard AS 2213–1984 50mm Pin Type Couplings and Drawbar Eyes for Trailers; and
- (c) be built to the dimensions mentioned in the standard; and
- (d) not be worn away more than is recommended in the standard.

### **169—Attachment of couplings and drawbar eyes on roadtrains**

A drawbar-type coupling, or drawbar eye, used in a road train must be built and positioned so:

- (a) when the road train is moving, the drawbar can move at least 15° upwards or downwards from the position it occupies when the road train is parked on level ground; and
- (b) the pivot point of the coupling is not over 300 millimetres forward of the rear of the trailer to which it is attached; and
- (c) it is at a height of at least 800 millimetres, but not over 950 millimetres, when the road train is unloaded and parked on level ground.

### **170—Branding of couplings and drawbar eyes on roadtrains**

A drawbar-type coupling, or drawbar eye, used on a vehicle built after June 1991 that forms part of a road train must be clearly and permanently marked in accordance with Australian Standard AS 2213–1984 50mm-Pin Type Couplings and Drawbar Eyes for Trailers with:

- (a) the name or trademark of its manufacturer; and
- (b) its D-value rating.

### **171—Tow coupling overhang on road trains**

- (1) In this rule:

*tow coupling overhang*, of a vehicle, means the horizontal distance from the centre of the axle group, or the centre line of the single axle, at the rear of the vehicle to the pivot point of the coupling near the rear of the vehicle.

- (2) The tow coupling overhang of a motor vehicle, except a prime mover, used in a road train must not be more than the greater of:
  - (a) 30% of the distance from the centre of the front axle to the centre of the axle group or single axle at the rear of the vehicle; and
  - (b) 2.7 metres.
- (3) The tow coupling overhang of a semi-trailer, or a dog trailer consisting of a semi-trailer and converter dolly, used in a road train must not be more than 30% of the distance from the point of articulation to the centre of the axle group or single axle at the rear of the vehicle.
- (4) The tow coupling overhang of another dog trailer used in a road train must not be more than 30% of the distance from the centre of the front axle group or single axle to the centre of the axle group or single axle at the rear of the vehicle.



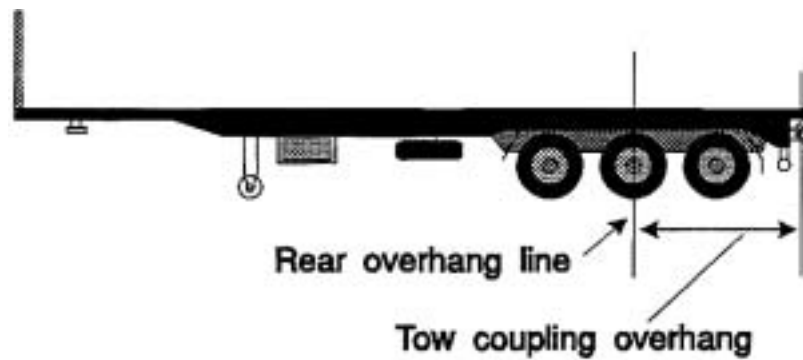

Tow coupling overhang—semi-trailer with extra coupling at rear

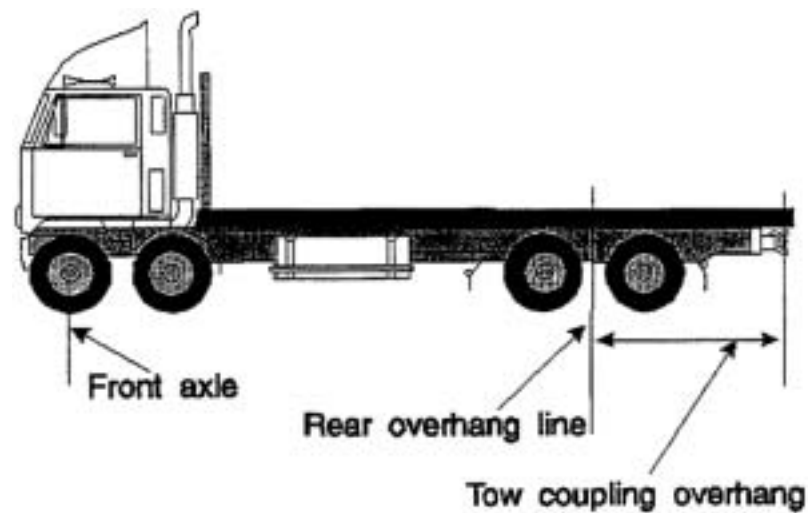

Tow coupling overhang—motor vehicle

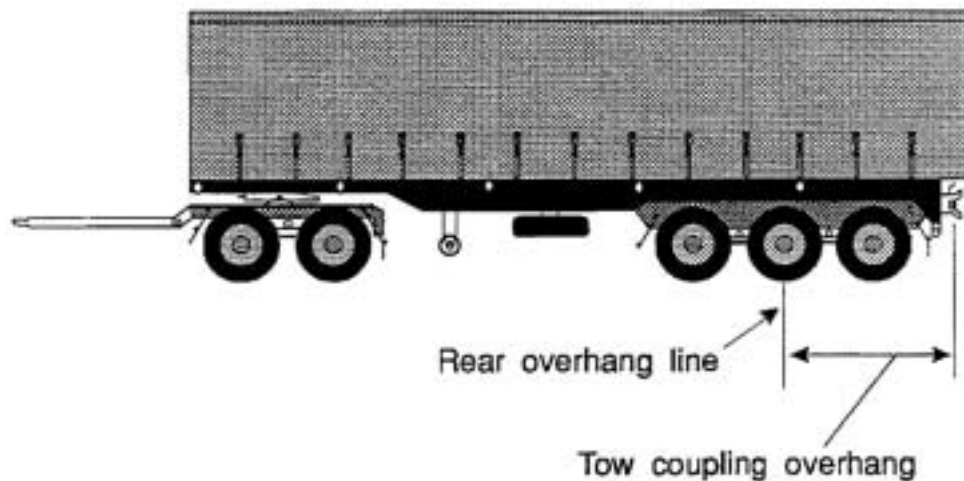

Tow coupling overhang—dog trailer

## Part 14—Other matters

### 172—Vehicle equipment

A vehicle is taken to have equipment mentioned in the Vehicle Standards only if the equipment is in working order.

### 173—Restored vehicles

- (1) For the Vehicle Standards, a restored vehicle is taken to have been built when it was originally built and not when it was restored.
- (2) In this rule:

*restored vehicle* means a vehicle that is being, or has been, restored to its manufacturer's specifications, so far as it is practicable to meet the specifications.

### 174—Retractable axles

- (1) For the Vehicle Standards, a retractable axle is taken to be an axle only when it is in the lowered position.
- (2) In this rule:

*retractable axle* means an axle with a means of adjustment enabling it to be raised or lowered relative to the other axles in the axle group.

### 175—Measurement of distance between parallel lines

For the Vehicle Standards, a distance between 2 parallel lines is measured at right angles between the lines.

### 176—Interpretation of certain second edition ADRs

The words "left" and "right" in the following second edition ADRs have the opposite meaning in the application of the ADRs, in accordance with the Vehicle Standards, to a motor vehicle with a left-hand drive:

- ADR 8 Safety Glass
- ADR 12 Glare Reduction in Field of View
- ADR 14 Rear Vision Mirrors
- ADR 16 Windscreen Wipers and Washers
- ADR18 and ADR 18A Location and Visibility of Instruments
- ADR 35 and ADR 35A Commercial Vehicle Braking Systems.

**Note—**

The following table contains a list of some terms used in the third edition ADRs and the corresponding term used in the Vehicle Standards.

Third edition ADRs	Vehicle Standards
dipped-beam headlamp	low-beam (for a headlight)
front fog lamp	front fog light
rear fog lamp	rear fog light
wheelguard	mudguard
main-beam headlamp	high-beam (for a headlight)
reversing lamp	reversing light
direction indicator lamp	direction indicator light
stop lamp	brake light

Third edition ADRs	Vehicle Standards
rear registration plate lamp	number plate light
front position (side) lamp	parking light
rear position (side) lamp	tail light
end-outline marker lamp	front or rear clearance light
external cabin lamp	external cabin light
internal lamp	interior light
side marker lamp	side marker light
daytime running lamp	daytime running light
rear reflex reflector, non-triangular	rear reflector
front reflex reflector, non-triangular	front reflector
side reflex reflector, non-triangular	side reflector

## Dictionary

**50 millimetre kingpin** means a kingpin meeting the dimension requirements for a 50 millimetre kingpin in Australian Standard AS 2175–1990 Articulated Vehicles Kingpins.

**75 millimetre kingpin** means a kingpin with the dimensions mentioned in rule 165 (3).

**90 millimetre kingpin** means a kingpin meeting the dimension requirements for a 90 millimetre kingpin in Australian Standard AS 2175–1990 Articulated Vehicles Kingpins.

**adopted standard**—see rule 24.

**ADR**—see rule 14.

**air brake** means an air-operated or air-assisted brake.

**another jurisdiction** means another State or a Territory of the Commonwealth.

**articulated bus** means a bus with at least 2 rigid sections that allow passengers access between the sections and are connected to allow rotary movement between the sections.

**Australian Standard** or **Australian/New Zealand Standard** means a standard published by or under the authority of Standards Australia (alone or jointly with others).

**axle** means 1 or more shafts, positioned in a line across a vehicle, on which 1 or more wheels intended to support the vehicle turn.

**axle group** means a single, tandem, twinsteer, tri, or quad axle group.

**B-double** means a combination consisting of a prime mover towing 2 semi-trailers where the first semi-trailer is connected to the prime mover by a fifth wheel coupling and the second semi-trailer is connected to the first semi-trailer by a fifth wheel coupling.

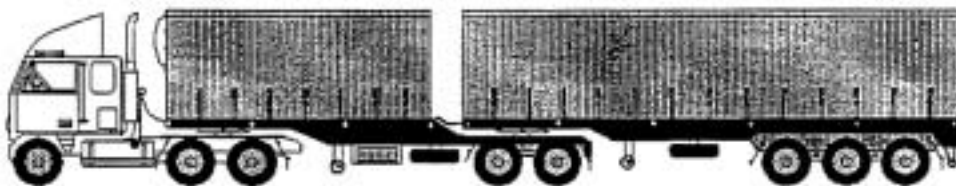

B-double

**braking system**, of a vehicle, means all the brakes of the vehicle and all the components of the mechanisms by which they are operated.

**British Standard** means a standard approved for publication on behalf of the British Standards Institution.

**British Standards Institution** means the institution of that name established under royal charter in the United Kingdom.

**bus** means a motor vehicle built mainly to carry people that seats over 9 adults (including the driver).

**car** means a motor vehicle built mainly to carry people that:

- (a) seats not over 9 adults (including the driver); and
- (b) has a body commonly known as a sedan, station wagon, coupe, convertible, or roadster; and
- (c) has 4 or more wheels.

**centre line**, of an axle group, means:

- (a) a line located midway between the centre lines of the outermost axles of the group; or
- (b) if the group consists of 2 axles, one of which is fitted with twice the number of tyres as the other axle—a line located one-third of the way from the centre line of the axle with more tyres towards the centre line of the axle with fewer tyres.

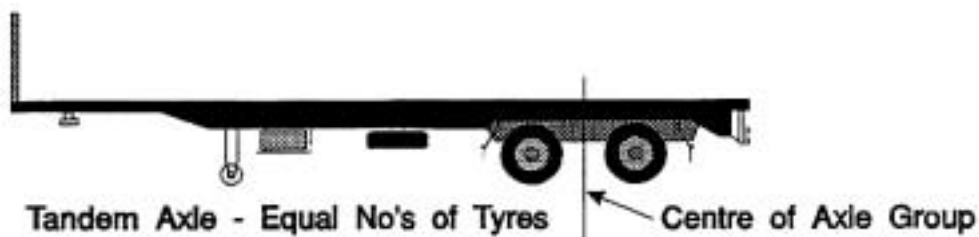

Centre line of a tandem axle group fitted with an equal number of tyres on each axle

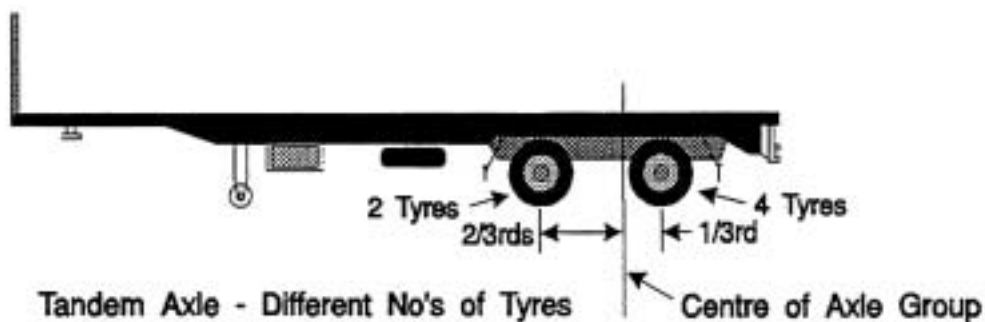

Centre line of a tandem axle group fitted with a different number of tyres on each axle

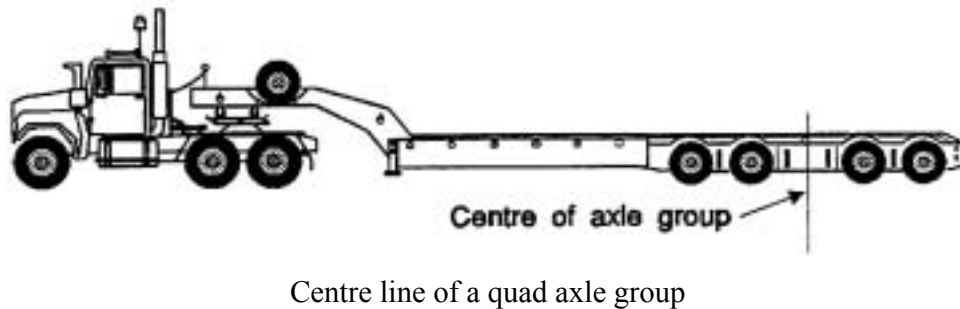
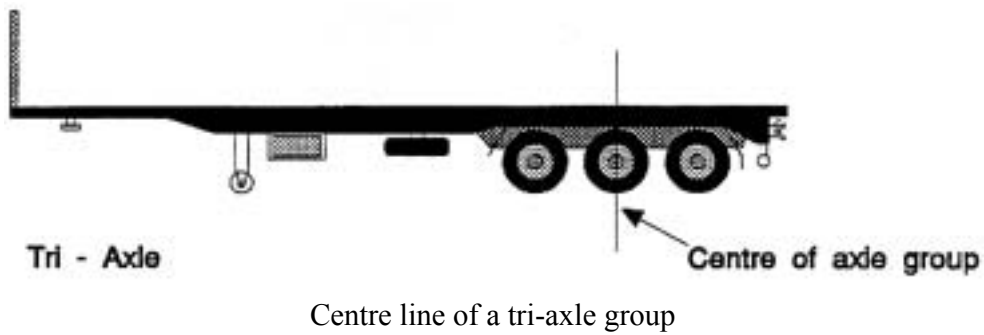

**combination** means a group of vehicles consisting of a motor vehicle connected to 1 or more vehicles.

**controlled access bus** means a bus, except an articulated bus, over 12.5 metres long.

**converter dolly** means a trailer with 1 tandem axle group or single axle and a fifth wheel coupling, designed to convert a semi-trailer into a dog trailer.

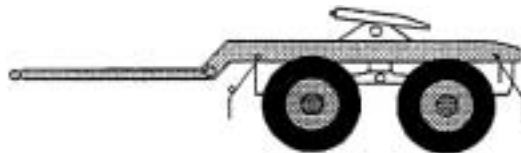

Converter dolly

**dangerous goods** has the meaning given by regulation 2.2 of the *Road Transport Reform (Dangerous Goods) (South Australia) Regulations 1998*.

**daytime** means the period beginning at sunrise and ending at sunset.

**dog trailer** means a trailer (including a trailer consisting of a semi-trailer and converter dolly) with:

- (a) 1 axle group or single axle at the front that is steered by connection to the towing vehicle by a drawbar; and
- (b) 1 axle group or single axle at the rear.



Dog trailer

**drawbar** means a part of a trailer (except a semi-trailer) connecting the trailer body to a coupling for towing purposes.

**drive** includes be in control of.

**driver**, of a vehicle, means the person driving the vehicle.

**emergency brake** means a brake designed to be used if a service brake fails.

**emergency vehicle** means a vehicle driven by any of the following in the course of his or her duty:

- (a) a member of an emergency services organisation within the meaning of the *Fire and Emergency Services Act 2005*;
- (b) an authorised officer under the *Emergency Management Act 2004*;
- (c) a person engaged in the provision of ambulance services under the *Ambulance Services Act 1992*;
- (d) a person engaged in the provision of services on behalf of St. John Ambulance Australia South Australia Incorporated;
- (e) a member of the Australian Customs Service;
- (f) a member of the armed forces of the Commonwealth engaged in police, fire fighting or ambulance duties or duties in connection with the urgent disposal of explosives or any emergency;
- (g) an employee of Airservices Australia engaged in fire fighting duties or duties in connection with any emergency.

**fifth wheel coupling** means a device, other than the upper rotating element and the kingpin (which are parts of a semi-trailer), used with a prime mover, semi-trailer, or a converter dolly to permit quick coupling and uncoupling and to provide for articulation.

**front fog light** means a light used to improve the illumination of the road in case of fog, snowfall, heavy rain or a dust storm.

**GTM** (gross trailer mass) means the maximum loaded mass transmitted to the ground by the axles of a trailer when it is connected to a towing vehicle:

- (a) as specified by the manufacturer; or
- (b) as specified by an Australian Authority if:
  - (i) the manufacturer has not specified a maximum loaded mass transmitted to the ground by the axles of the trailer when connected to a towing vehicle; or
  - (ii) the manufacturer cannot be identified; or
  - (iii) the trailer has been modified to the extent that the manufacturer's specification is no longer appropriate.

**GVM** of a vehicle means the maximum loaded mass of the vehicle:

- (a) as specified by the vehicle's manufacturer; or
- (b) as specified by an Australian Authority if:
  - (i) the manufacturer has not specified a maximum loaded mass; or
  - (ii) the manufacturer cannot be identified; or

- (iii) the vehicle has been modified to the extent that the manufacturer's specification is no longer appropriate.

**high-beam**, for a headlight or front fog light fitted to a vehicle, means that the light is built or adjusted so, when the vehicle is standing on level ground, the top of the main beam of light projected is above the low-beam position.

**left**, for a vehicle, means to the left of the centre of the vehicle when viewed by a person in the vehicle who is facing to the front of the vehicle.

**load** of a vehicle, or in or on a vehicle, means:

- (a) all the goods, passengers and drivers in or on the vehicle; and
- (b) all fuel, water, lubricants and readily removable equipment carried in or on the vehicle and required for its normal operation; and
- (c) personal items used by a driver of the vehicle; and
- (d) anything that is normally removed from the vehicle when not in use,

and includes a part of a load as so defined.

**low-beam**, for a headlight or front fog light fitted to a vehicle, means that the light is built or adjusted so, when the vehicle is standing on level ground, the top of the main beam of light projected is:

- (a) not higher than the centre of the headlight or fog light, when measured 8 metres in front of the vehicle; and
- (b) not over 1 metre higher than the level where the motor vehicle is standing, when measured 25 metres in front of the vehicle.

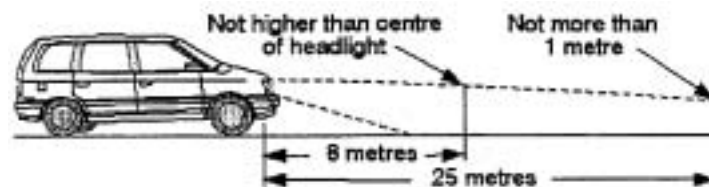

A headlight in the low-beam position

**moped** means a motor bike or trike with an engine cylinder capacity of not over 50 millilitres and a maximum speed of not over 50 kilometres an hour.

**motor bike** means a motor vehicle with 2 wheels, and includes a 2 wheeled motor vehicle with a sidecar attached to it that is supported by a third wheel.

**motor trike** means a motor vehicle with 3 wheels, but does not include a 2 wheeled motor vehicle with a sidecar attached to it that is supported by a third wheel.

**motor vehicle** means a vehicle built to be propelled by a motor that forms part of the vehicle.

**mudguard** means a fitting or device, with or without a mudflap, that is built and fitted to a vehicle in a way that will, as far as practicable, catch or deflect downwards any stone, mud, water, or other substance, thrown up by the rotation of the wheel to which the fitting or device is fitted.

**national standard**—see rule 15.

*point of articulation* means:

- (a) the axis of a kingpin for a fifth wheel; or
- (b) the vertical axis of rotation of a fifth wheel coupling; or
- (c) the vertical axis of rotation of a turntable assembly; or
- (d) the vertical axis of rotation of the front axle group, or single axle, of a dog trailer; or
- (e) the coupling pivot point of a semi trailer.

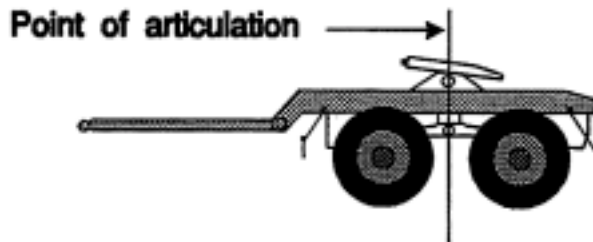

Point of articulation—fifth wheel coupling on a converter dolly (forming the front axle group of a dog trailer)

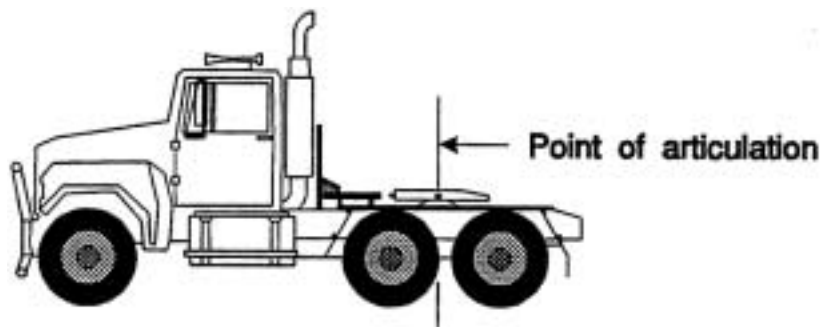

Point of articulation—fifth wheel on a prime mover

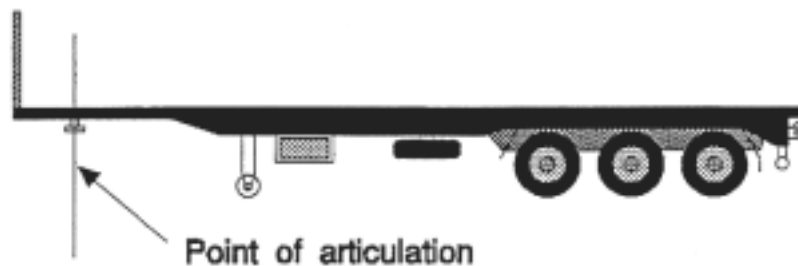

Point of articulation—kingpin for fifth wheel

*pole-type trailer* means a trailer that:

- (a) is attached to a towing vehicle by a pole, or an attachment fitted to the pole; and
- (b) is ordinarily used for transporting loads, such as logs, pipes, structural members or other long objects, that are generally capable of supporting themselves like beams between supports.



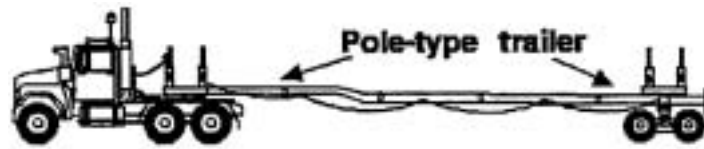

Pole-type trailer

**police officer** means a member of South Australia Police, a member of the Australian Federal Police or a service police officer within the meaning of the *Defence Force Discipline Act 1982* of the Commonwealth, as in force from time to time.

**police vehicle** means a vehicle driven by a police officer in the course of his or her duty.

**prime mover** means a motor vehicle built to tow a semi-trailer.

**quad axle group** means a group of 4 axles in which the horizontal distance between the centre lines of the outermost axles is over 3.2 metres, but not over 4.9 metres.

**rear fog light** means a light used on a vehicle to make it more easily visible from the rear in dense fog.

**rear overhang**, of a vehicle, means the distance between the rear overhang line and the rear of the vehicle.

**rear overhang line** means:

- (a) if there is a single axle at the rear of the vehicle—the centre line of the axle; or
- (b) if there is an axle group at the rear of the vehicle—the centre line of the axle group, determined without regard to the presence of any steerable axle or retractable axle in the group unless all axles in the group are steerable or retractable.

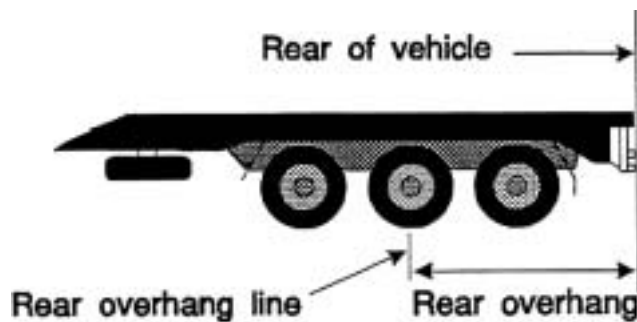

Rear overhang and rear overhang line—vehicle with tri-axle group at rear

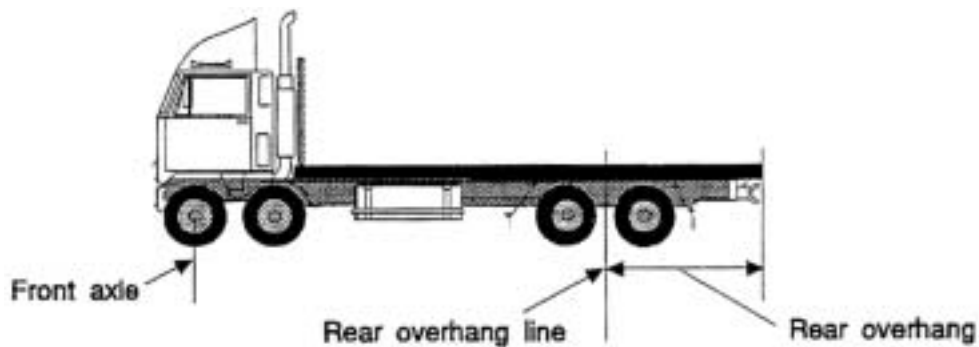

Rear overhang and rear overhang line—motor vehicle

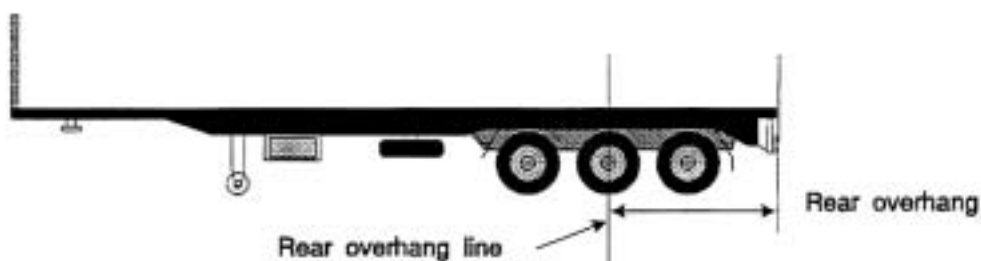

Rear overhang and rear overhang line—semi-trailer

**repeater horn** means a device that makes a sound alternating between different tones or frequencies on a regular time cycle.

**right**, for a vehicle, means to the right of the centre of the vehicle when viewed by a person in the vehicle who is facing to the front of the vehicle.

**road**—see rule 8.

**road-related area**—see rule 9.

**road tank vehicle** has the same meaning as in the sixth edition of the Australian Code for the Transport of Dangerous Goods by Road and Rail.

**road train** means a combination, other than a B-double, consisting of a motor vehicle towing at least 2 trailers (counting as a single trailer a converter dolly supporting a semi-trailer).



Road train

**second edition ADR**—see rule 17.

**semi-trailer** means a trailer that has:

- (a) 1 axle group or single axle to the rear; and
- (b) a means of attachment to a prime mover that would result in some of the load being imposed on the prime mover.

**service brake**, for a vehicle, means the brake normally used to decelerate the vehicle.

**single axle** means an axle not forming part of an axle group.

**single axle group** means a group of 2 or more axles, in which the horizontal distance between the centre lines of the outermost axles is less than 1 metre.

**spring brake** means a brake using 1 or more springs to store the energy needed to operate the brake.

**Standards Australia** means:

- (a) Standards Association of Australia; or
- (b) Standards Australia International Limited; or
- (c) Standards Australia Limited (ACN 087 326 690).

**State Government enforcement vehicle** means a vehicle driven by:

- (a) an authorised officer appointed under section 35(1) of the *Road Traffic Act 1961*; or
- (b) an authorised officer under the *Dangerous Substances Act 1979*; or

(c) a fisheries officer under the *Fisheries Act 1982*,  
in the course of his or her duty.

**tandem axle group** means a group of at least 2 axles in which the horizontal distance between the centre lines of the outermost axles is at least 1 metre, but not over 2 metres.

**third edition ADR**—see rule 18.

**trailer** means a vehicle that is built to be towed, or is towed, by a motor vehicle, but does not include a motor vehicle that is being towed.

**tri-axle group** means a group of at least 3 axles in which the horizontal distance between the centre lines of the outermost axles is over 2 metres, but not over 3.2 metres.

**turntable** means a bearing built to carry vertical and horizontal loads, but does not allow quick separation of its upper and lower rotating elements, and that is used to connect and allow articulation between:

- (a) a prime mover and semi-trailer; or
- (b) the steering axle or axle group of a dog trailer and the body of the trailer; or
- (c) a fifth wheel coupling and the vehicle to which it is mounted.

**twinsteer axle group** means a group of 2 axles:

- (a) with single tyres; and
- (b) fitted to a motor vehicle and connected to the same steering mechanism; and
- (c) the horizontal distance between the centre lines of which is at least 1 metre, but not over 2 metres.

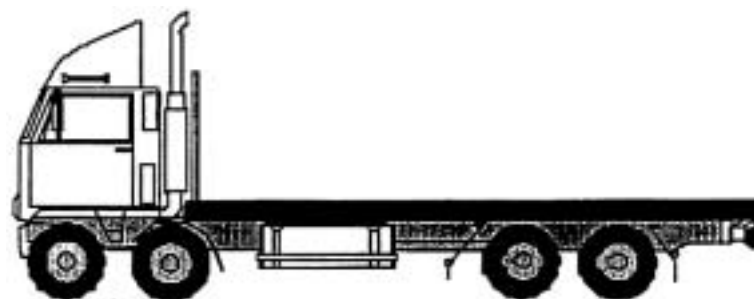

Twinsteer axle group

Twinsteer axle group on a motor vehicle

**vacuum brakes** means vacuum-operated or vacuum-assisted brakes.

**vehicle** includes the equipment fitted to, or forming part of, the vehicle.

**yellow** includes amber.

## Legislative history

### Notes

- Please note—References in the legislation to other legislation or instruments or to titles of bodies or offices are not automatically updated as part of the program for the revision and publication of legislation and therefore may be obsolete.
- Earlier versions of these rules (historical versions) are listed at the end of the legislative history.
- For further information relating to the Act and subordinate legislation made under the Act see the Index of South Australian Statutes or [www.legislation.sa.gov.au](http://www.legislation.sa.gov.au).

### Principal rules and variations

New entries appear in bold.

Year	No	Reference	Commencement
1999	235	<i>Gazette 25.11.1999 p2597</i>	1.12.1999: r 2
2001	124	<i>Gazette 7.6.2001 p2195</i>	7.6.2001: r 2
2005	196	<i>Gazette 8.9.2005 p3282</i>	8.9.2005: r 2
2006	32	<i>Gazette 16.2.2006 p608</i>	16.2.2006: r 2
<b>2007</b>	<b>47</b>	<b><i>Gazette 26.4.2007 p1398</i></b>	<b>30.4.2007: r 2</b>

### Provisions varied

New entries appear in bold.

Entries that relate to provisions that have been deleted appear in italics.

Provision	How varied	Commencement
Pt 1		
r 2	<i>omitted under the Legislation Revision and Publication Act 2002</i>	8.9.2005
<b>Pt 2</b>		
<b>r 9</b>	<b>varied by 47/2007 r 4</b> <b>(e) deleted by 47/2007 r 4</b>	<b>30.4.2007</b> <b>30.4.2007</b>
Pt 5		
r 27		
r 27(1)	varied by 124/2001 r 3(a)	7.6.2001
r 27(2)	<i>deleted by 124/2001 r 3(b)</i>	7.6.2001
r 34		
r 34(3)	(c)—(e) deleted by 32/2006 r 4	16.2.2006
Pt 6		
r 57A	inserted by 124/2001 r 4	7.6.2001
Pt 7		
r 70		
r 70(3)	varied by 124/2001 r 5(a)	7.6.2001

r 70(5)	inserted by 124/2001 r 5(b)	7.6.2001
Pt 8		
r 118		
r 118(1)		
exempt vehicle	varied by 124/2001 r 6(a)	7.6.2001
	substituted by 32/2006 r 5(1)	16.2.2006
special use vehicle	varied by 124/2001 r 6(b), (c)	7.6.2001
	varied by 32/2006 r 5(2)	16.2.2006
r 118(4)	substituted by 32/2006 r 5(3)	16.2.2006
r 119	substituted by 196/2005 r 4	8.9.2005
r 119A	inserted by 196/2005 r 4	8.9.2005
Pt 10		
r 150		
r 150(3)	<i>deleted by 47/2007 r 5</i>	<b>30.4.2007</b>
Pt 11	substituted by 196/2005 r 5	8.9.2005
Dictionary		
<i>Australian Standard</i>	<i>deleted by 196/2005 r 6(1)</i>	8.9.2005
Australian Standard or Australian/New Zealand Standard	inserted by 196/2005 r 6(1)	8.9.2005
emergency vehicle	varied by 32/2006 r 6(1)	16.2.2006
	<b>varied by 47/2007 r 6(1)</b>	<b>30.4.2007</b>
	<b>(h), (i) deleted by 47/2007 r 6(1)</b>	<b>30.4.2007</b>
GTM	substituted by 124/2001 r 7(a)	7.6.2001
	<b>varied by 47/2007 r 6(2)</b>	<b>30.4.2007</b>
<b>GVM</b>	<b>substituted by 47/2007 r 6(3)</b>	<b>30.4.2007</b>
<b>load</b>	<b>substituted by 47/2007 r 6(4)</b>	<b>30.4.2007</b>
<i>Ministerial Council Standards Association of Australia</i>	<i>deleted by 47/2007 r 6(5)</i>	<b>30.4.2007</b>
<i>Standards Australia</i>	<i>deleted by 196/2005 r 6(2)</i>	8.9.2005
Standards Australia	inserted by 196/2005 r 6(2)	8.9.2005
State Government	inserted by 124/2001 r 7(b)	7.6.2001
enforcement vehicle		
	varied by 32/2006 r 6(2), (3)	16.2.2006
	<b>varied by 47/2007 r 6(6)</b>	<b>30.4.2007</b>
<i>Transport Department enforcement vehicle</i>	<i>deleted by 124/2001 r 7(c)</i>	7.6.2001
<i>vehicle registration authority</i>	<i>deleted by 47/2007 r 6(7)</i>	<b>30.4.2007</b>

## Historical versions

Reprint No 1—7.6.2001

8.9.2005

16.2.2006